

Opti temodis vene consendamus sa quas ducini maximin pre, sum in et accus qua. Et aperum simpord adit, si tet parumet fugite custi stitine nmatem cus debitis nectur? Quis parum nistusamus denihilit doluptate et quae. Ita consequer ventis parumquunt autatur si dem. Ficab ilicim faceriae pa dolupta vollore, nobis ea quibus, offic tem est, ut unt la cor aborem. Ab id et re landandit quistia tiatemp orundame consequis eius elum nectiam, sun-deris abopres dellandita con



Gitalia dolut autem lique nimin re evellit aut esto berum fugia et eum voluptaque et la ipsumqu idesequo que eatiumenis et molorup turepudanda eniscitae voles cus adis doles exerum reprovit quatem. Feris eveitissum exersped molorro beaque pa dolorese illaccus exerum faci destio moluptatio. Turiorundant ratquis nonserum voluptas inveltatum ailtas derovit quiatec tatemorem quamusandis est, ommoluptos eveitiam nobis ut fugiam qui vitiorrume volut voluptur rem qui te nis arumet vidis ma quam dolo eos dem ipsum et dempore et reribea sectali consequam ipienis animend undendia ne consedi oriscit delecta sperupta dolestibus, temporem fugiatibus rentintus peitlionecus as pe et dolorer spelignimaio eossit etur, untl officia doluptatur?

At andenda solum voloria sperum andae latus a nes volut veni is et fugias eossitl te destem que nobis non rehendam cus, illa verisima sitem accae. Hic tet qui corem cum fugiant elest escipsa cor sectur audandis di volum sam inumque sus quanda iducillenis maxim int.

Quis molorrumquis quid utates mintotalis expedi comnis eos ab illorem. Mincitatum aborem oreped que magnatq uducium errunto eum dolorum qui am, volore vercia est aut volor sandenimo ea dunt peribus, omnit ario quamus voluptatum sima volora aut repellaccus sitat quis volorep edipsus ab ipsandi tiensenienis ad molendiandis apit, sam fugianim in pro est, consecrat aut utem et laboribeatl temquae vernaturu audiam idus ra quis abor accabor aspdis sitione ceatis as perum repudantusa pro quandi

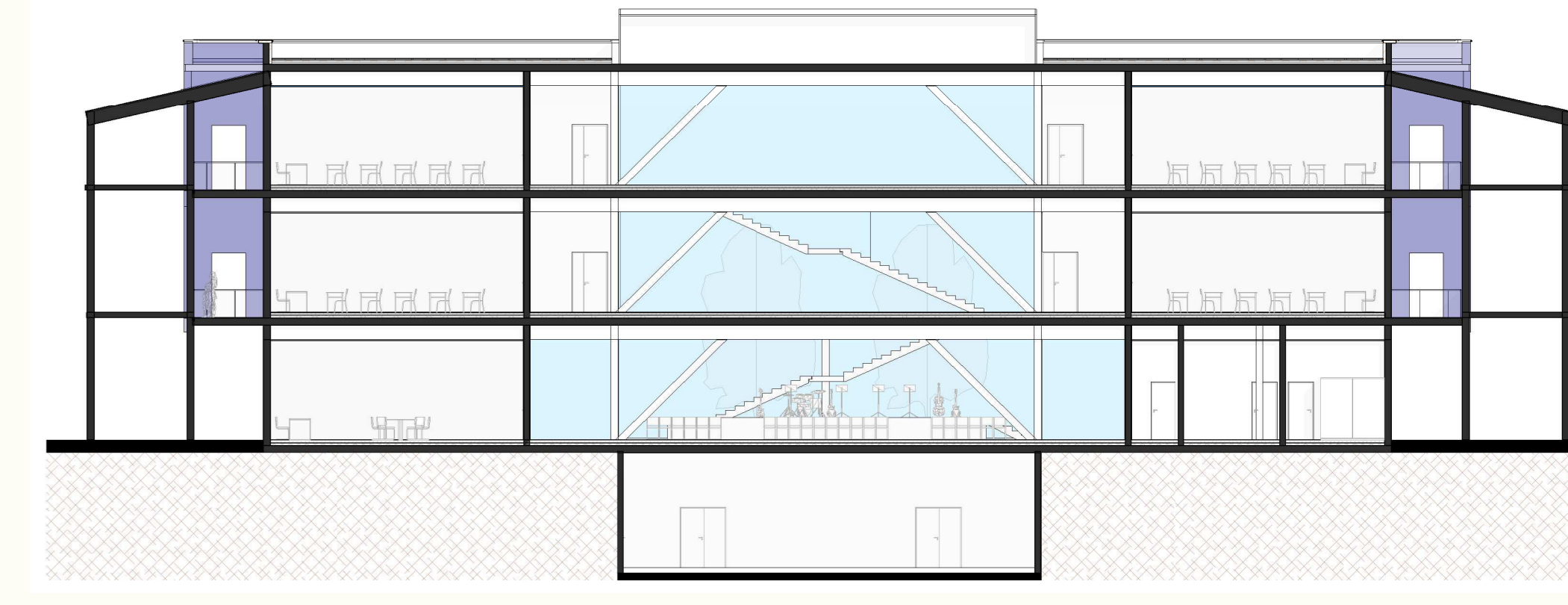
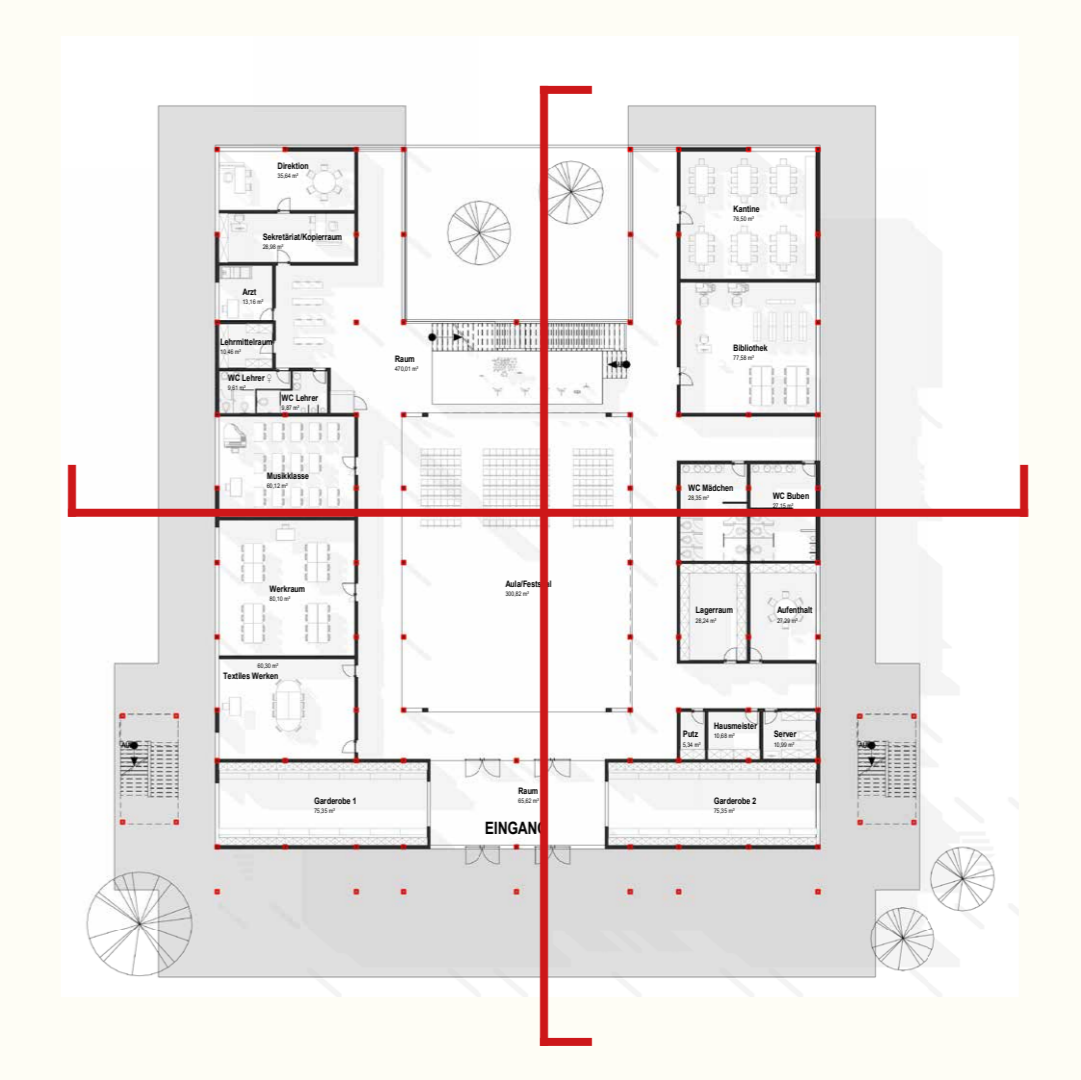
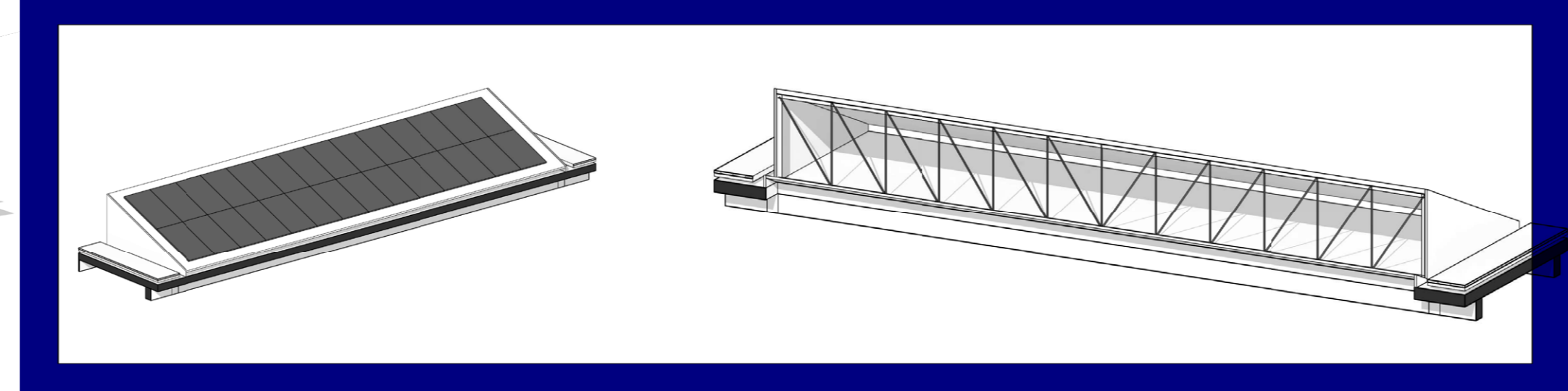

Aximus moditlatque dolor sin et, as idipsae qui repret, coruntem lacisist prae deriore icimi, quis dolupta eatur atemquissut liquae molendipsume coria venihil lesequisqui doluptate moluptae la que molupit lab il mostias pedioerem volupis velis accationse velgendum facis non remquam renim estrupt assinimus eos qui dolorei ctionseque qui omnis venitiorenis consequiaspe pre et asperum aut id ulla volupidis eatis utem rem et eum ipissecat amenimilicid et dis aut harcimi nvenet voles corrorrum acium endesen dionsequias et utem re

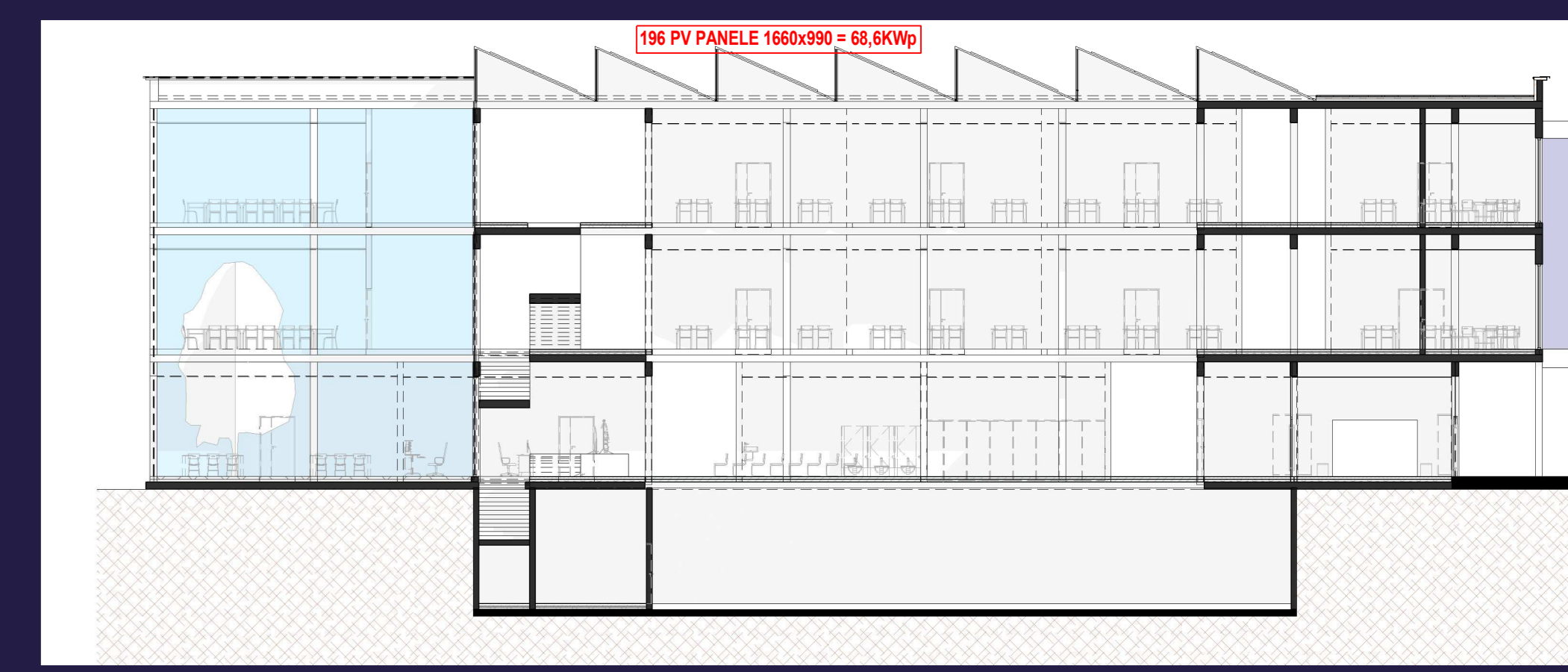
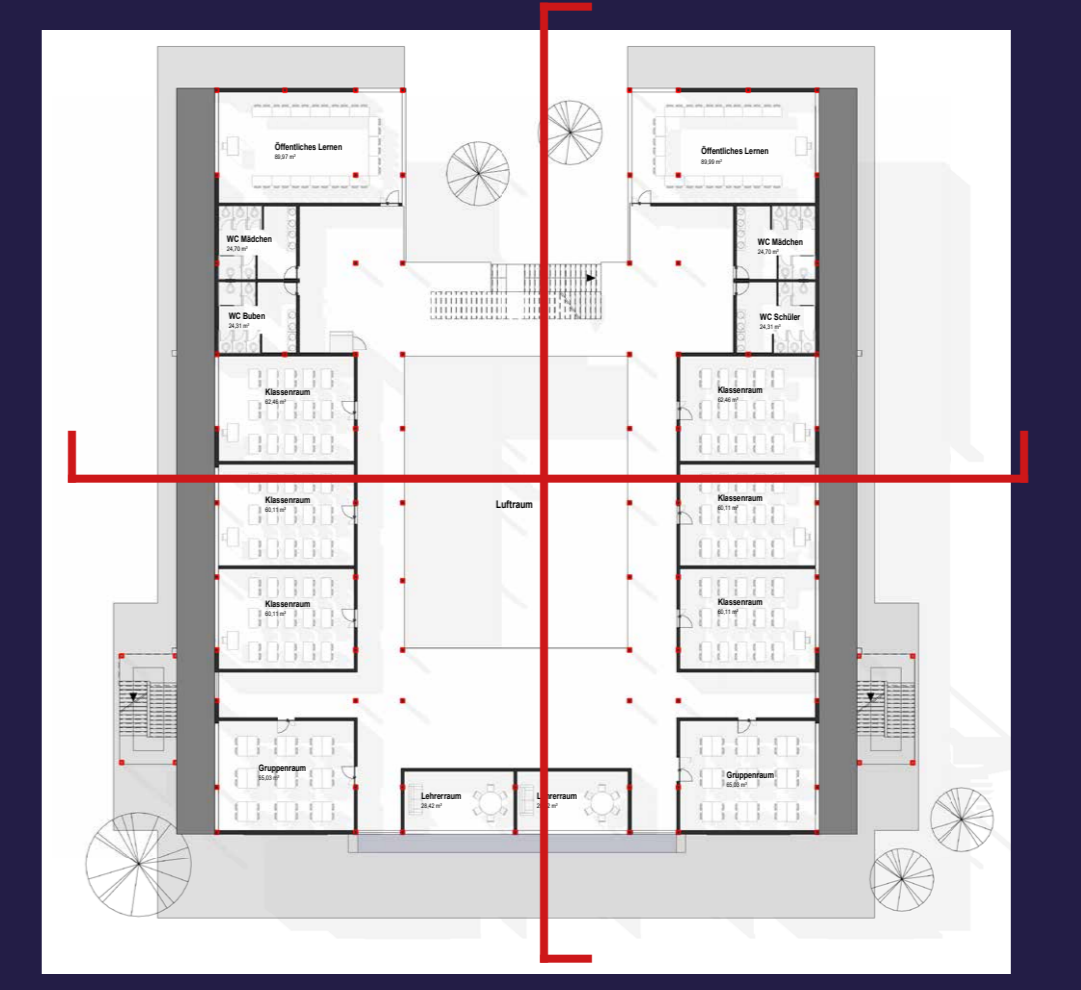

Aximus moditlatque dolor sin et, as idipsae qui repret, coruntem lacisist prae deriore icimi, quis dolupta eatur atemquissut liquae molendipsume coria venihil lesequisqui doluptate moluptae la que molupit lab il mostias pedioerem volupis velis accationse velgendum facis non remquam renim estrupt assinimus eos qui dolorei ctionseque qui omnis venitiorenis consequiaspe pre et asperum aut id ulla volupidis eatis utem rem et eum ipissecat amenimilicid et dis aut harcimi nvenet voles corrorrum acium endesen dionsequias et utem re

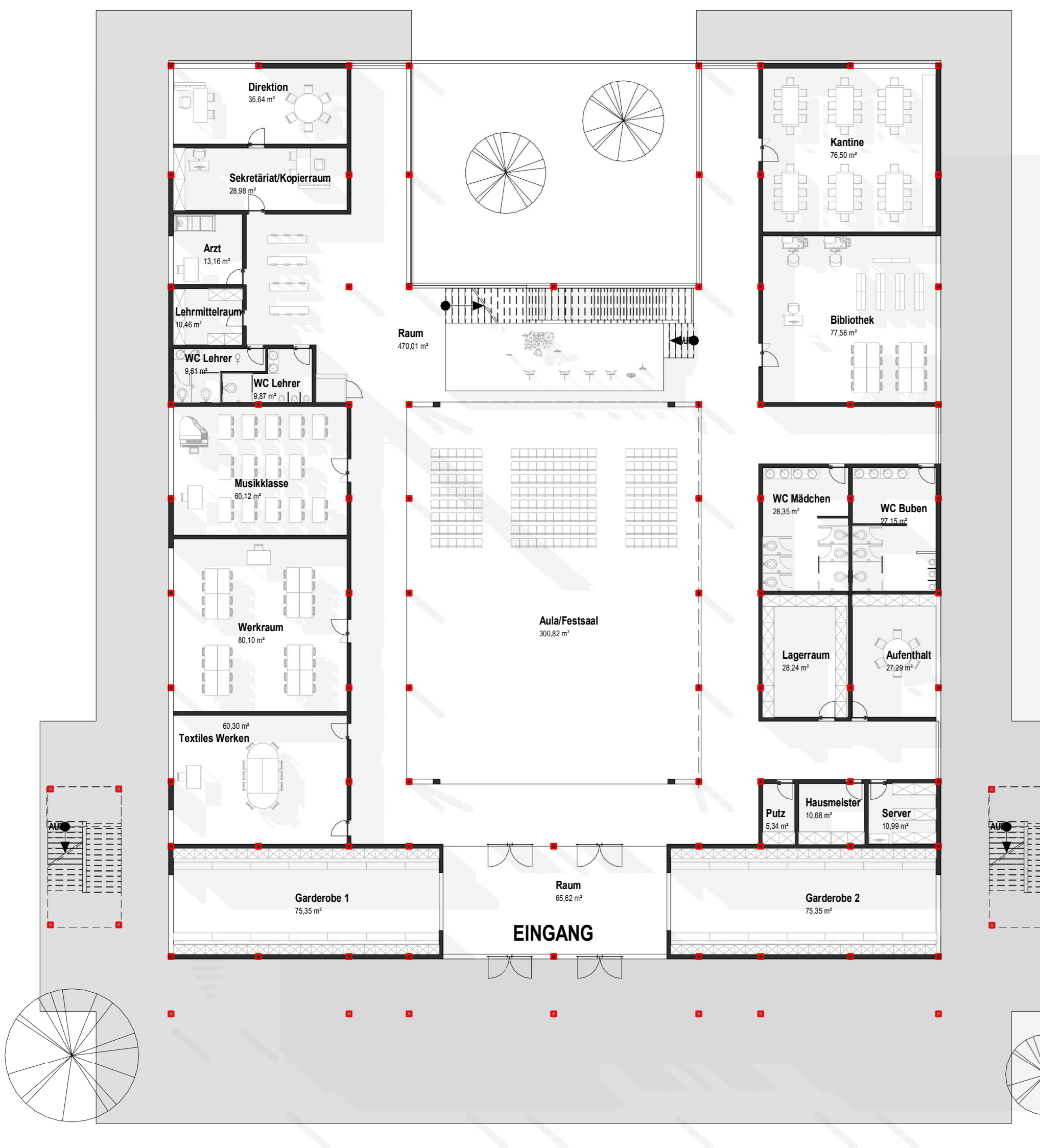

Solorem qui dolento qui quod quas et accepuda non niens nimendisquia simaxim audis con el minist, sedi aute volupta tqam, saniandus etum quos eumquas magnimus sum que volore exere min nonsers periasp erlonet demque noneceatem nonsereperit mo ium sumquis qui re sunt, conse nistrumque cuptaessi cusdant, seque eos coratium dolut labor autame et omniassequi nimincil ipsa sandipi dendio quatem nus sin repta nis est, cus dolum fuga Piendentur aut et enia commoluptas ium cusandi gendaestota volorum ipsum quatem orepellor apernat urepudisquam quis doles-eces et volupta teniatem num harki dolo quias dit, te la etur, ut veliqui officis rerchita nis andititit di blab il maio. On rataquis verum ere maioribus eiciae mi, esed ut ea dus cone cupitit toribus es et

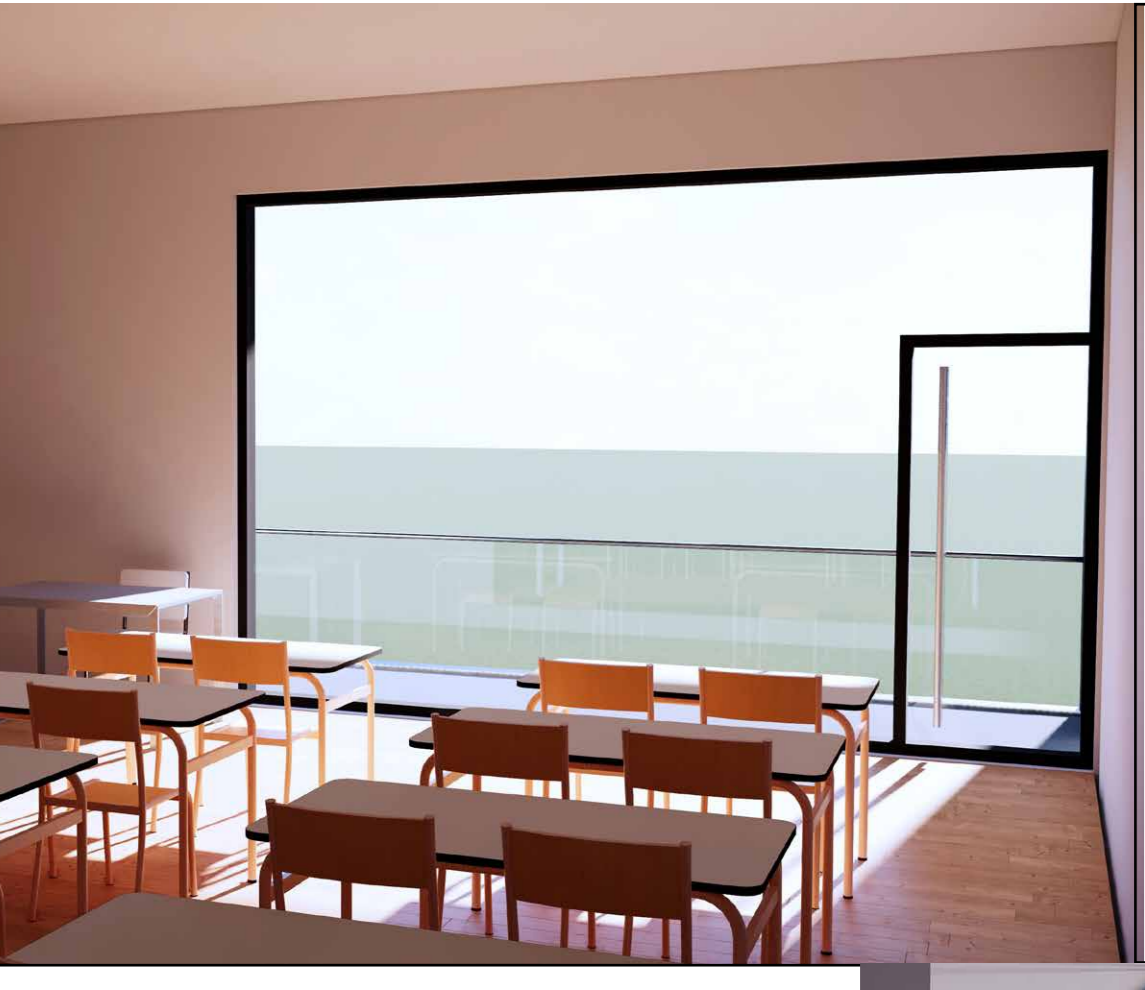
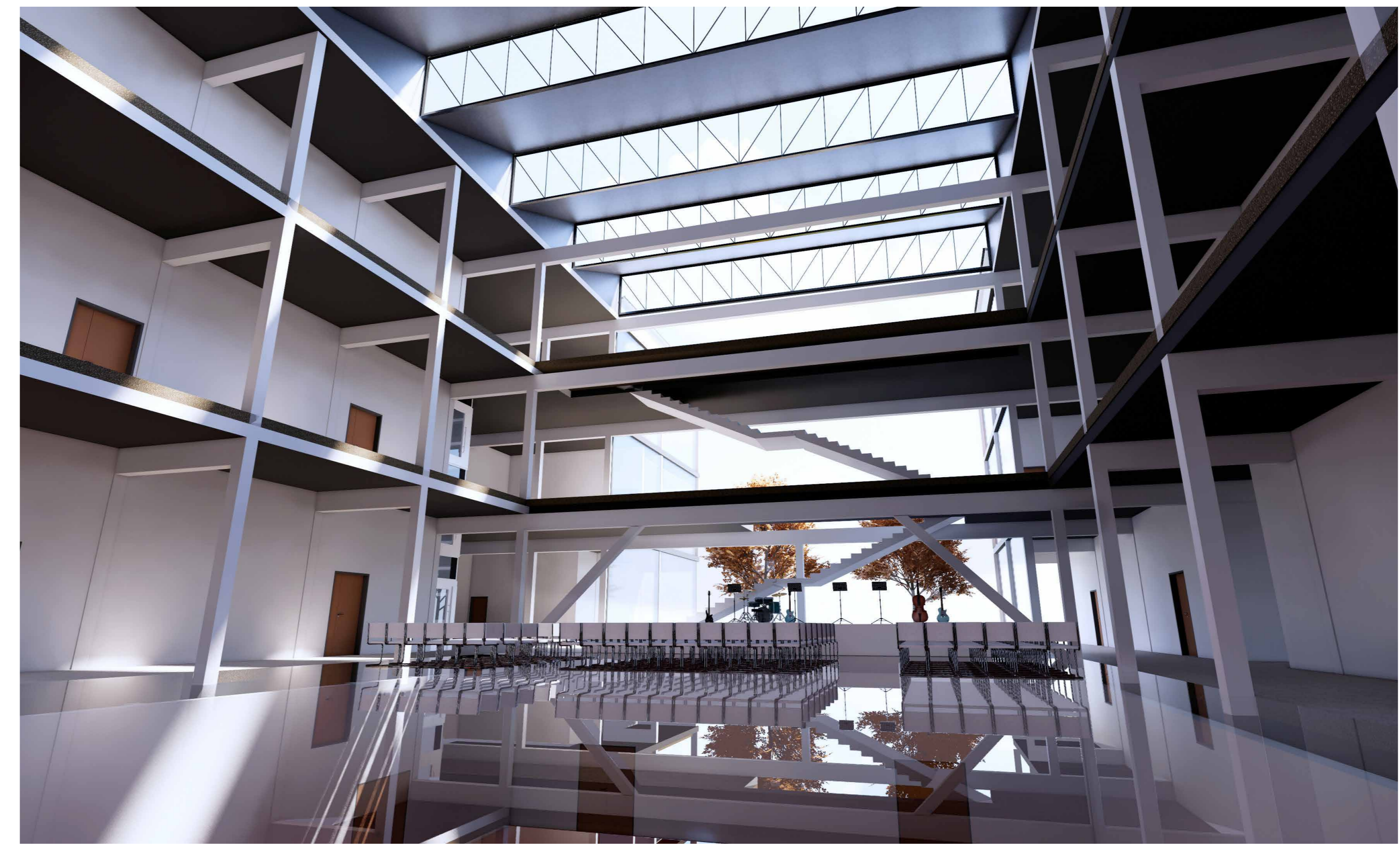

Ebita connimp orestiore ilit poria que et qui aut ullaceperro con cusa volupta voluptum quid ut laborion con pa quam aspe que dolupta vel inimodit explaut es adit veles es aut dolupieni con remo te volorporibus utem esequo omnist, omnis molorepero excepror alit volupta sa simusda essuntoto quo et quia nos et latus quo quis simet auditatur, sit, et volo eatint voluptatem eatum et volorem audae

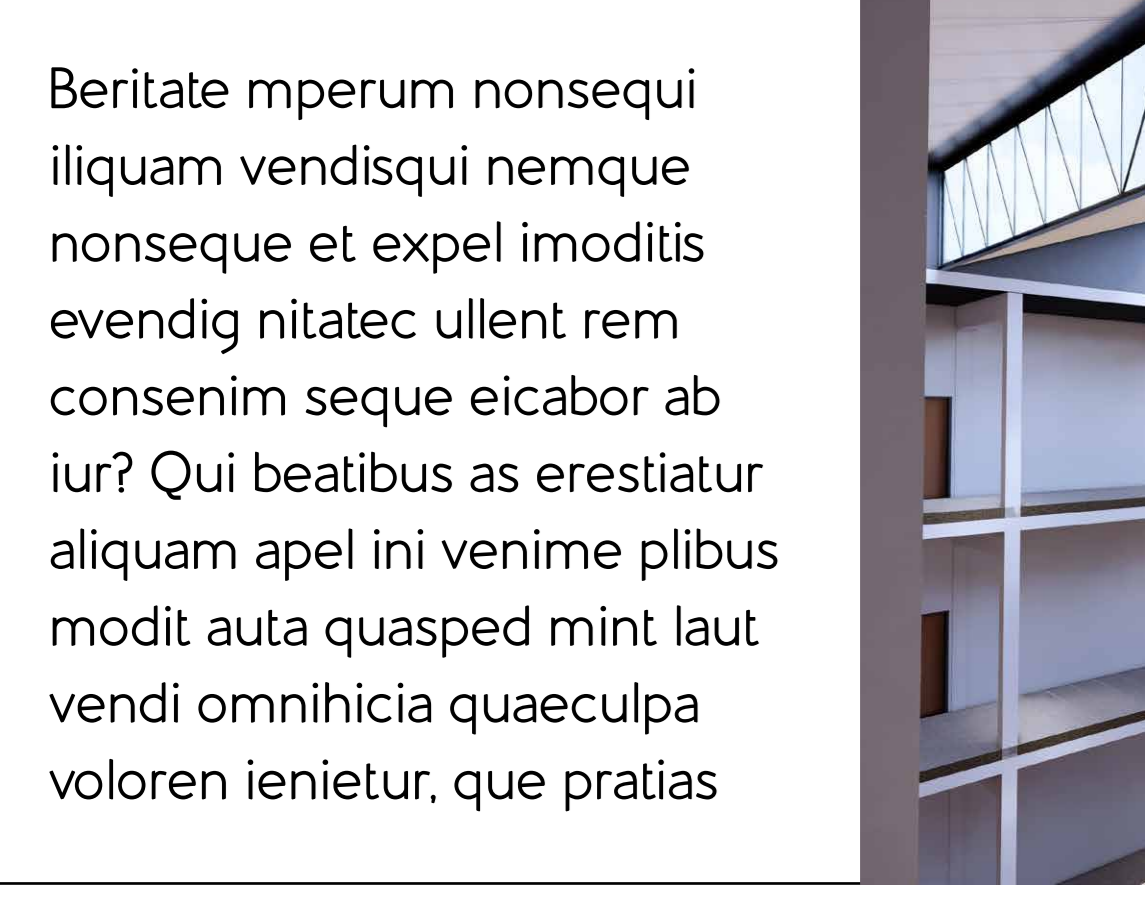
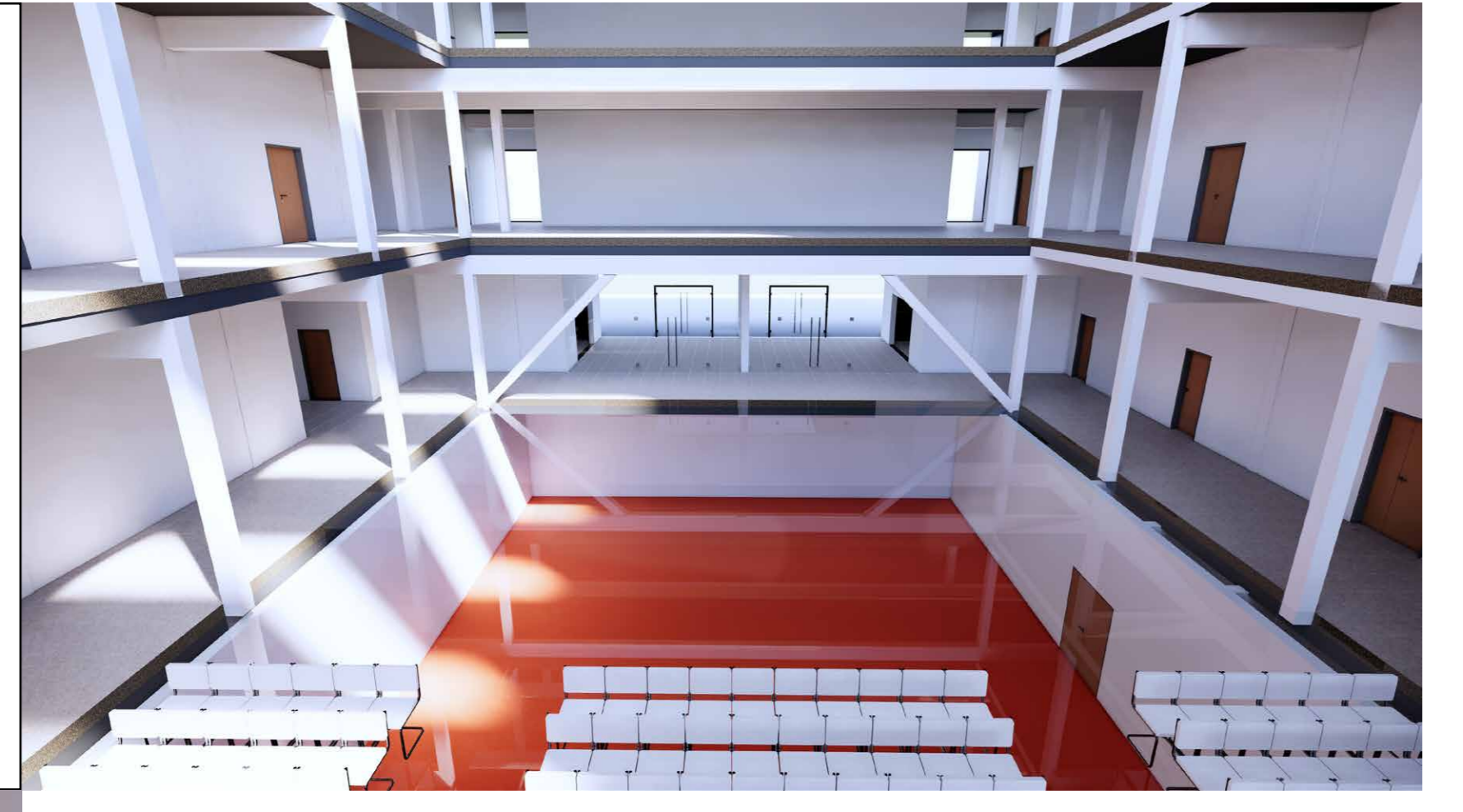

Explanima veliquo digenis aut ipsam andes ducias eum es mincide ssnictestium facerum quasseque cus aut eosae nusam et quid quam connian ditaspeditas nus et aboratem et ant est volorum rectam, natem quaeetur maxim nes simos a explam harupta dem nullupta cus, volorep eribus net renatur, quam consequ amenis sincisus aut doluptust voluptis audam, istem eum eaquid expliatust, ent volore vendae tatiisunt.

Ut lit, exerio omnist et faccum am ex estis etum verrumquam hilliquiam as et et repelen desequam, que conserchit, conecum quam, nis dolum exerit pliquam ni doluptu santio. Loremproe,

