

DIM Design & Installation Manual North America

Facade on Wood – Swisspearl Patina NXT Design Line





Table of Contents

Swisspearl	4
The Self-ventilating Facade	6
Product Range	8
Installation	10
Accessories	22
Storing and Handling	26
Care and Maintenance	27
Health and Safety	29
Onsite Handling	30

Swisspearl

Swisspearl

Swisspearl is one of the leading European manufacturers of multi-capability fibre cement building products. Our products and solutions add exciting new design opportunities for moulding attractive, durable settings for people's lives. But Swisspearl is more than mere products. We also help make all kinds of design and construction projects easier as well as more profitable, inspiring and effective. And for us, all construction also involves building relations with people, making your day better, and helping you make the day better for others.

Product Information

Swisspearl fibre cement is a modern building material made from natural and environmentally friendly raw materials. The technology has been developed by Swisspearl, having more than 90 years of experience within the manufacture of fibre cement. Our wide experience ensures a sustainable product which has accumulated all the advantages of fibre cement. The facade range can be used in all self-ventilated light weight facade constructions.

Featuring properties such as non-combustibility, sound and weather insulation as well as high impact strength, Swisspearl fibre cement boards are the ideal facade material.

Quality

Swisspearl product specifications and classifications comply with EN 12467:2012 and 13501-1:2007+ A1:2009

The facade range

- is manufactured in accordance with the quality management system ISO 9001:2015
- complies with the provisions set out in the Construction Products Regulation (EU) No. 305/2011

Product warranty

Warranty conditions are available on request from your local Swisspearl office or dealer.

Note!

The following limitations exist for the Swisspearl Patina design line

Do not use the following facade constructions: Sloped facade with deviation over 5 degrees from vertical, curved facade or non ventilated facade.

Disclaimer

The information and recommendations contained in this Design & Installation Manual ("DIM") are offered as a service to architects, constructors, installer and other persons involved with our products and are not intended to relieve them from their own responsibility. The information and recommendations provided herein are believed by Swisspearl Group to be accurate at the time of preparation of this DIM, or obtained from sources believed to be generally reliable. Swisspearl Group makes no warranty concerning the accuracy of the content of this DIM and shall not be liable for claims relating to any use regardless of whether it is claimed that the information or recommendations are inaccurate, incomplete, or otherwise misleading. The information and recommendations herein are intended to be used with the judgment and experience of professional personnel competent to evaluate the significance and limitations of the material contained. Swisspearl Group expressly disclaims any guarantees or warranties, expressed or implied, for anything described or illustrated herein and assumes no responsibility or liability for damages of any kind, including – without limitation – bodily harm, injury or damage to property inferred from this DIM or the use of the materials described herein.



The self-ventilating facade

A self-ventilating facade is a construction which helps minimise temperature variations in the wall throughout the year. Sunlight and heat are reflected away in the summertime, and insulation behind the facade boards reduces heat loss in lower temperatures. At the same time, the natural ventilation passing through the construction minimises condensation.

The self-ventilating facade has additional features and benefits.

The most important benefit is the protection of the underlying construction against weather, wind and moisture. Some moisture passes through the facade, but it is limited to a level that can either be drained away or eliminated by natural ventilation.

The drainage feature of the system works when rainwater or moisture penetrates through the gaps in the facade. The moisture runs down either the reverse of the facade boards, the windstopper, or the insulation. There should be ventilation openings at the base of the structure and above doors and windows. These openings will also help drain the water away from the construction.

The natural ventilation works by means of a chimney effect. The air enters at the bottom of the structure and on its way up through the facade takes moisture-laden air through the ventilation openings at the top of the structure or at window or door openings.

The boards can be installed with open horizontal joints or with joint profiles. Horizontal joints contribute minimally to the natural ventilation and therefore, profiles can be used in these joints, if required.

Swisspearl recommends increasing the ventilation area behind the facade boards when installing facade boards on taller buildings. In the table below, it is showing the recommended minimum ventilation cavities behind the facade boards.

Cladding height	min. cavity
< 20'	3/4"
20' - 99'	1"
> 99'	1 3/4"

Steel or timber framed construction

1. Swisspearl facade board
2. EPDM
3. Ventilated area
4. Timber batten
5. Cembrit Windstopper
6. Steel, timber framed construction with insulation or backwall

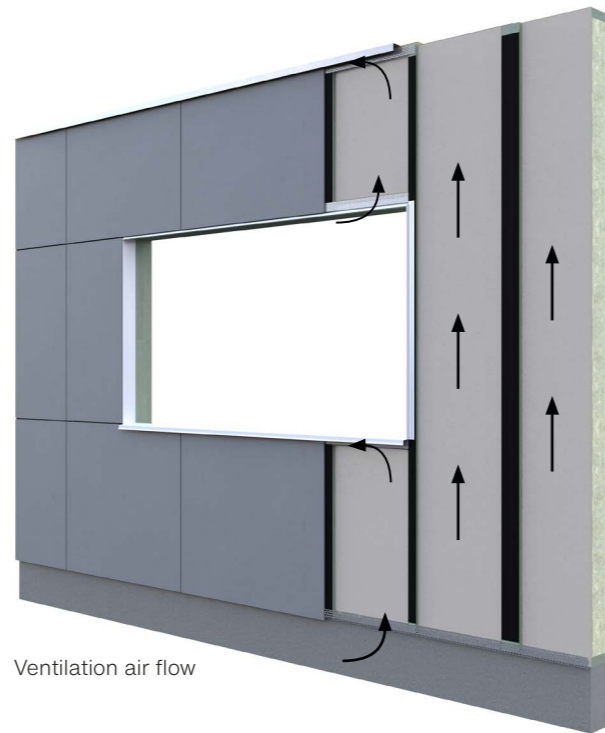

Ventilation air flow



Open joints

Joint profile

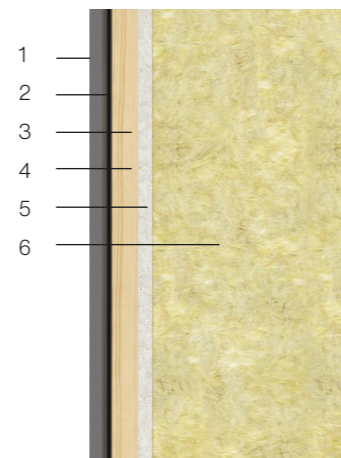

The self-ventilating facade

Ventilated Openings



Air is pulled into the construction through an opening at the base of the facade, and it must be ensured that unobstructed ventilation is possible throughout the facade's height. There should be a minimum free opening area of 3/4", or equivalent 200cm² per meter. If steel, aluminium or plastic perforated profiles are used, a ventilation area opening of minimum 200cm² per meter is required. The opening at the base is also used to drain moisture that has entered the facade.

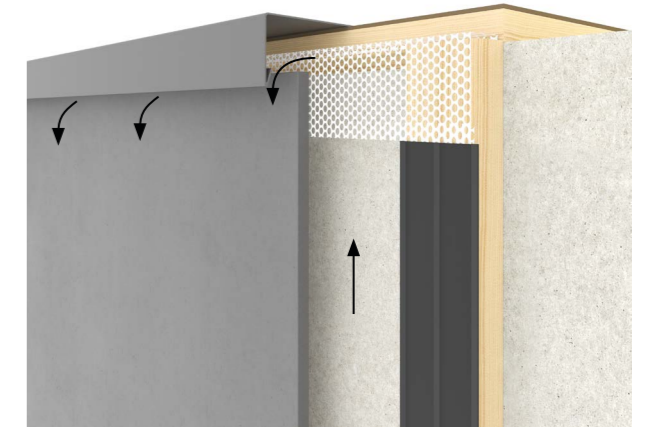

The passage of air must be maintained at the top of the facade whether it abuts a roof or other structure. Just as at the base, there must be a ventilation gap of a minimum of 3/4" or 200cm² per meter.



A horizontal ventilation opening of minimum 3/4" or equivalent to 200cm² per meter should be maintained beneath windows or other openings where a sill is used. This ventilation gap is usually formed between the top edge of the facade boards and the bottom edge of the sill. It is recommended that the sill projects a minimum of 1 1/4" beyond the front of the facade. This ensures that the water running from the sill does not enter the structure.



A horizontal free ventilation opening must be maintained above windows and doors as well. This ventilation gap must be at least 3/4" wide. If steel, aluminium or plastic perforated profiles are used, a ventilation area opening of minimum 200cm² per meter is required. The opening at the base is also used to drain moisture that has entered the facade.

Product Range

The Swisspearl Patina NXT design line

Swisspearl Patina Original

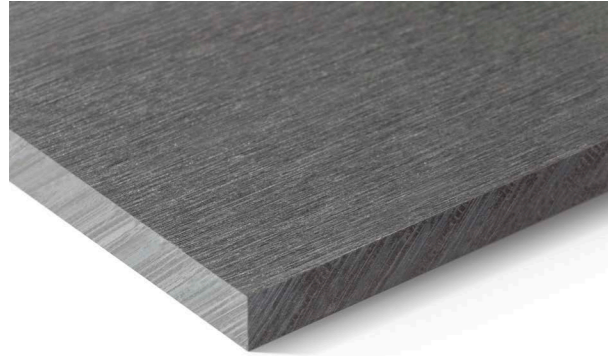

Swisspearl Patina Rough

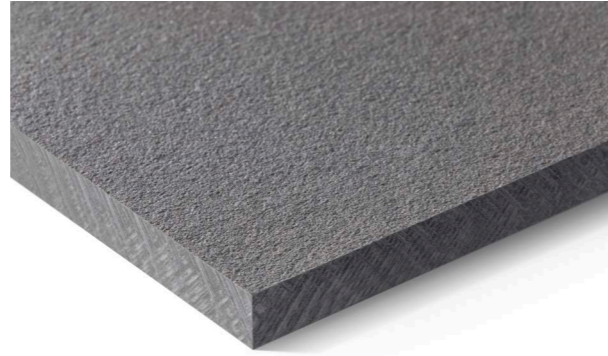

Swisspearl Patina Inline

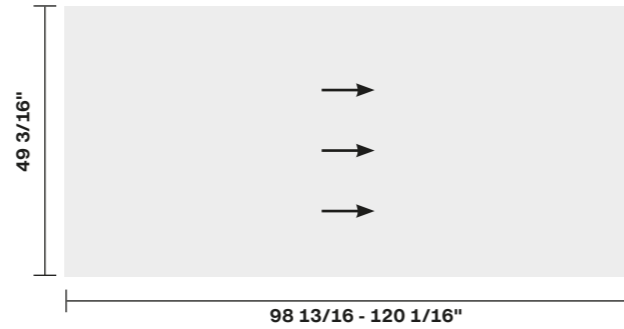

Directional grain

Swisspearl Patina's manufacturing process gives the boards a unique surface texture. This unique finish is enhanced by a process which adds a directional grain to the board - leaving the boards with a different appearance dependent on lighting and the angle of the board. By rotating boards within the facade makes it possible to obtain a playful visual effect depending on the viewer's position and the lighting conditions.

Quick facts	Type	Fire class	Thickness	Dimensions	Weight/m ²
Swisspearl Patina Original Swisspearl Patina Rough	Through coloured	A2,s1-d0	5/16"	49 3/16" x 98 13/16" 49 3/16" x 120 1/16"	26.68 pound pr. m ²
Swisspearl Patina Inline	Through coloured	A2,s1-d0	23/64"	49 3/16" x 98 13/16" 49 3/16" x 120 1/16"	31.09 pound pr. m ²

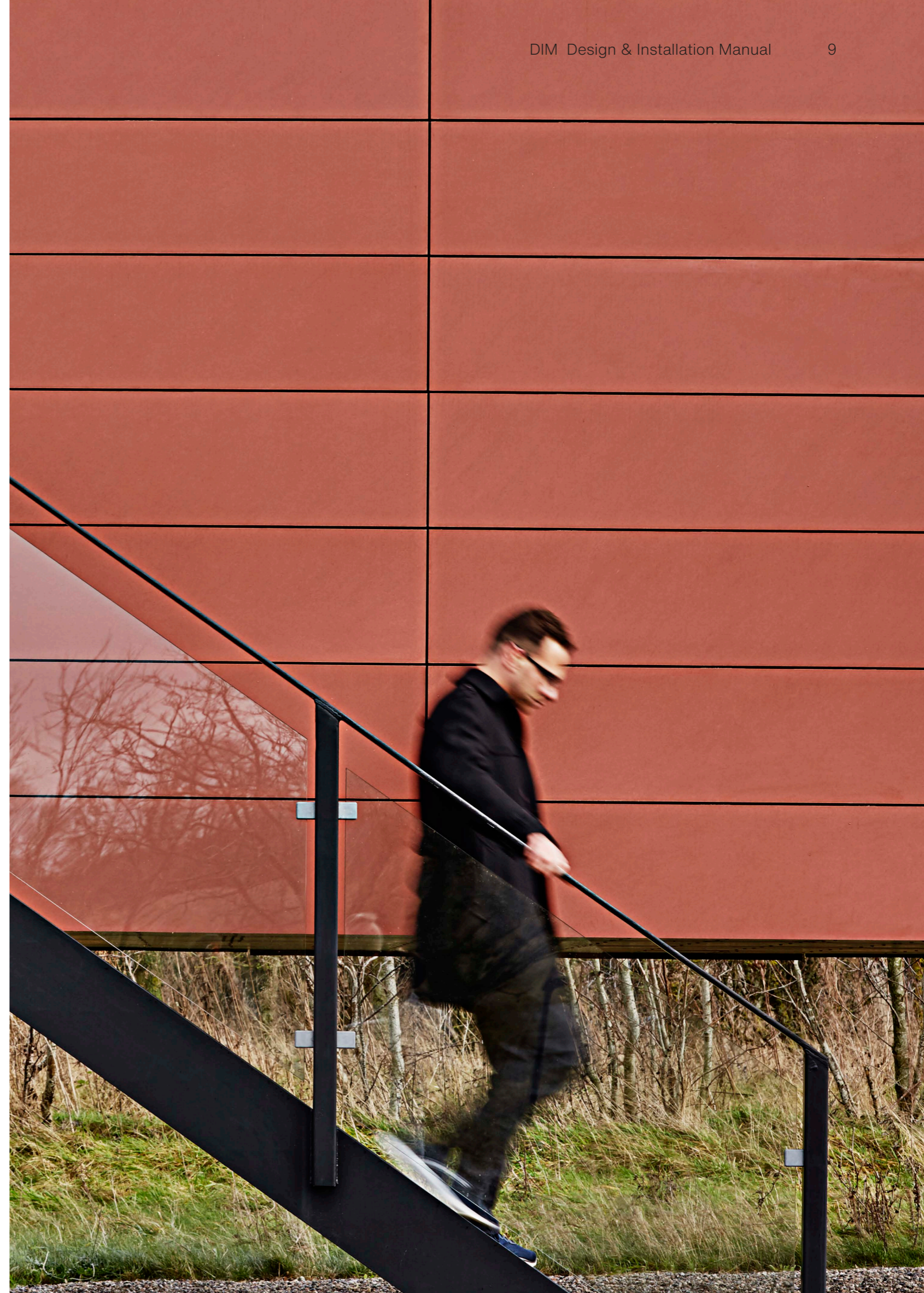

Installation

Substructure

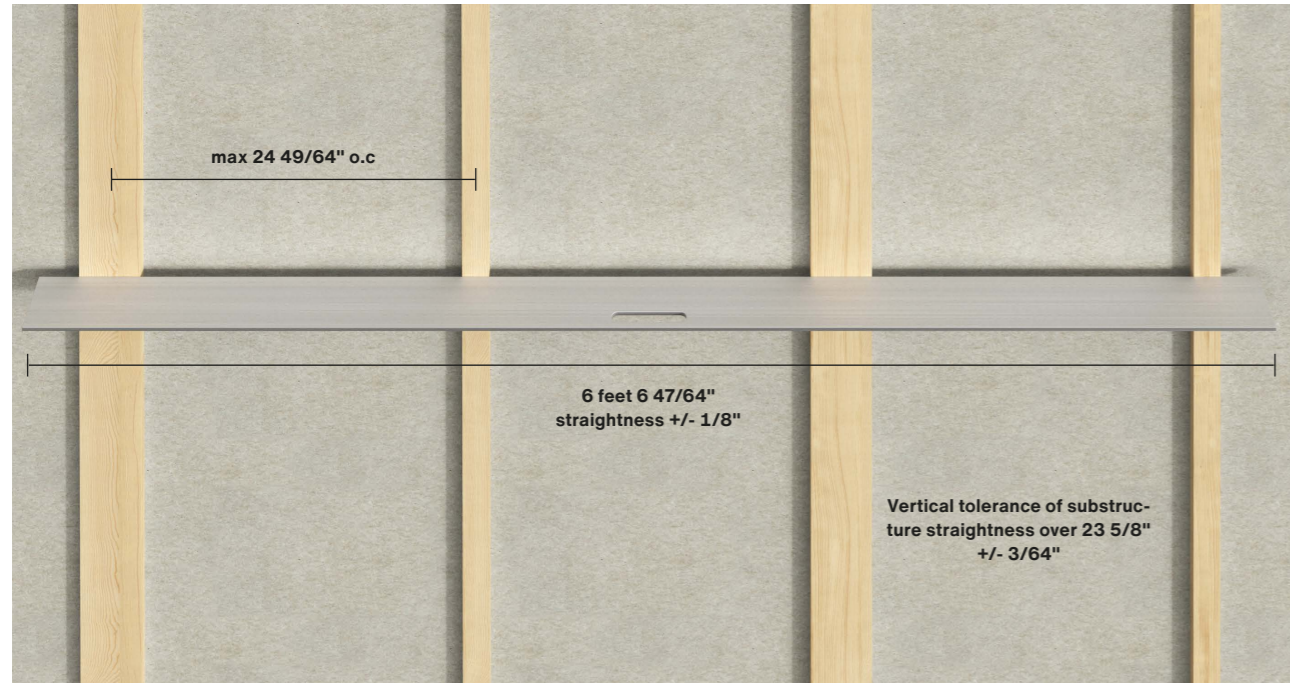

Straightness of substructure

Fastening substructure

Anchorage of the substructure on the load-bearing wall must follow all local standards and regulations.

Before installing the substructure on the load-bearing wall, it should be checked by the installer to ensure that it is straight and the substructure can be mounted safely.

Make sure to choose the correct anchorage system for the substructure suitable for the material. Always install the anchoring according to the manufacturer of the system/screw/bolt used.

Use the correct corrosion resistance according to the environment of the building's location.

Wind load calculations on how the substructure should be fixed to the load-bearing wall should be considered. This calculation will normally be done by a project/construction engineer.

Wood quality for substructure

Make sure that the quality of the wood used for the substructure follows country specific standards and regulations. Treated or untreated wood can be used for the substructure. The thickness is min 3/4"* Width at joints min 4" Width at middle batten 2"

Straightness of substructure

The horizontal tolerance of straightness for the substructure is +/- 1/8" measured with 6 feet 6 47/64" straight edge.

The vertical tolerance of straightness for the substructure is +/- 3/64" over 23 5/8" measured with straight edge.

*The minimum thickness of wood is 3/4", but the ventilation cavity depends on the height of the building, see page 6 for details.

Installation

Substructure



Installing 5/16" Swisspearl facade boards on timber frame

Max support distances:
23 5/8" o.c
Max screw centres: 23 5/8" o.c

Max wind load: Please refer to the wind load table for the correct distances for substructure and screws.

The following screws can be used for this solution:

Swisspearl Facade Wing Screw Wood, SCR-WW 4.9x38mm

Swisspearl Facade Screw Wood, SCR-W 4.8x30/38/44mm

There must be a ventilated cavity between the back of the facade panel and the insulation or windstopper. Read more about this in the section on "The self-ventilating facade".

Batten width should be minimum 4" for supporting battens, and 2" for central battens.

Joint gaps between boards should be a minimum of 5/16" and a maximum of 7/18".

When using timber battens, always use Swisspearl EPDM with profiled ribs.

Swisspearl recommends using an EPDM of the same width as the selected batten.

Swisspearl facade boards can also be installed on horizontal battens.

When using horizontal substructures, there must be a minimum 3/4" ventilated area behind the horizontal supporting battens.

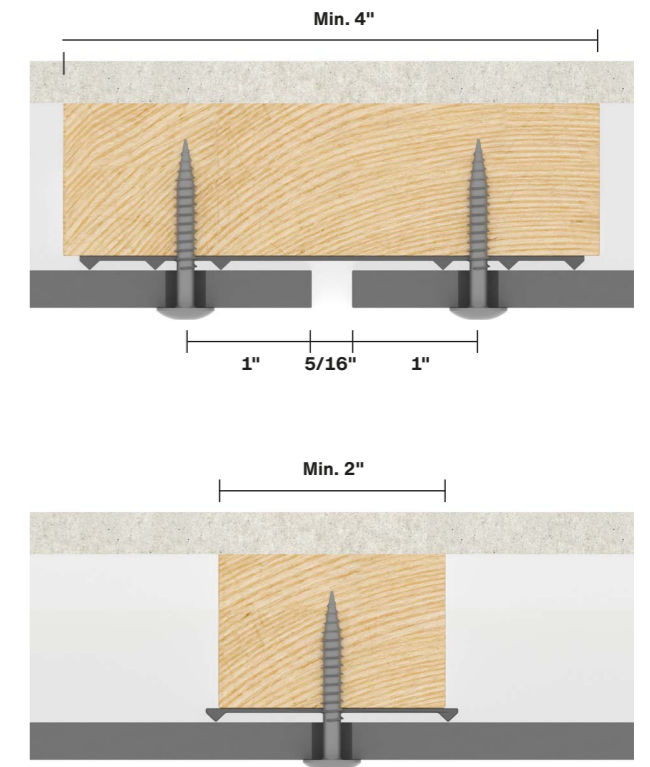

*wind load calculation assumes a Swisspearl Facade screw wood, SCR-W 4.8x38mm or SCR-W 4.9x38mm Wing Screw Wood.

Installation

Edge distances

Edge distances

Fibre cement is an organic material that expands and contracts according to humidity conditions. Consequently, it is very important that the boards are installed using the correct edge distances. If not mounted correctly, the strength of the board is compromised and it may result in cracking near corners and edges. Therefore, you should always pre-drill the Swisspearl facade boards using a Ø8mm drill suitable for fibre cement.

Horizontal and vertical installation

Swisspearl Patina design line
 Edge distances side: 1" and up to Max 4"
 Edge distances end: 3 1/6" and up to Max 4"

Note that the end distance (3 1/6") follows the direction of the substructure.

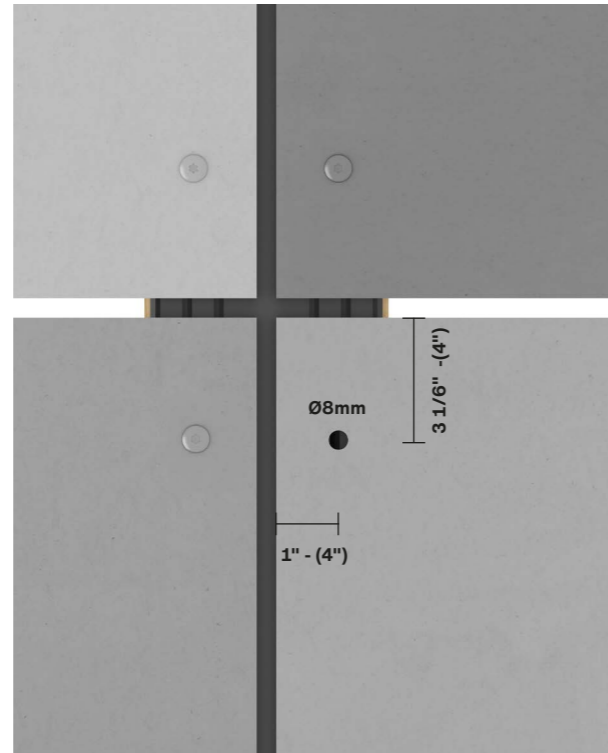

Example of vertical substructure - Swisspearl Patina design line

Installation

Edge distances

Swisspearl Patina Inline

Swisspearl Patina Inline is available in four dimensions:
 49 3/16" x 98 13/16"
 49 3/16" x 120 1/16"

Make sure to adhere to the installation principles in this manual when installing Swisspearl Patina Inline. The areas in which the installation of Swisspearl Patina Inline differs from the normal installation method will be explained below. Pre-drill the Swisspearl Patina Inline board using a Ø8mm drill suitable for fibre cement.

Edge distances

The edge distance of the hole is dependent on the direction of the support system - as the normal installation principles.

- Edge distances from the board end, in the direction of the support system, should be minimum Min. 3 1/6" up to max 4"
- The edge distance from the board side edges differs from the normal edge distance and should be minimum 1 1/4" and max 4"

If the board is mounted with horizontal lines as in fig. 3* the edge distance should be minimum 3 1/6"*, but as the milled lines will not necessarily match the edge distance, it should be placed at the nearest following top line.

If the board is mounted with vertical lines as in fig. 3** the edge distance should be minimum 1 1/4" for full size boards. If cut to size, please refer to the paragraph below. Please note that the screw should always be mounted at the top of a line and centred (fig. 1). The same applies to the installation on central battens (fig. 2).

Edge distance of cut to size boards

If the board is cut to size to be installed in connection with windows, doors or similar, it may not be possible to keep the edge distance at 1 1/4" due to the nature of the lines. It will be necessary to place the screw at the following top instead (fig. 4).

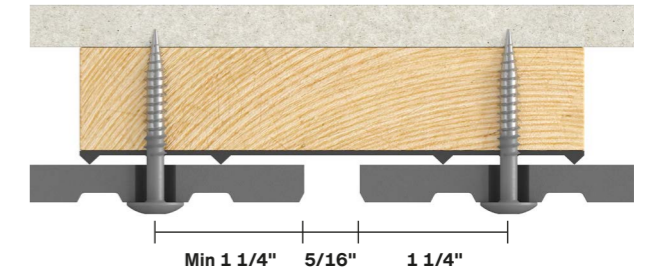

Fig. 1. Swisspearl Patina Inline installation on intermediate batten.

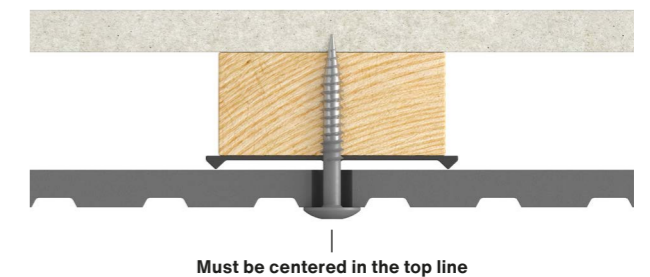

Fig. 2. Swisspearl Patina Inline installation on intermediate batten.

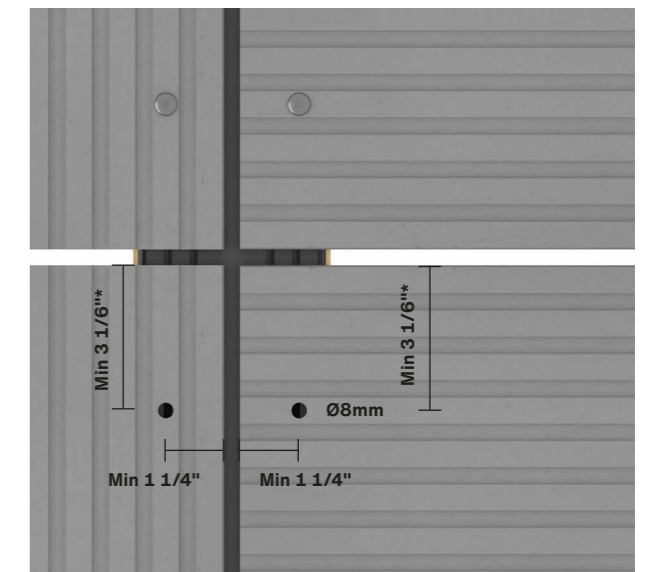

Fig. 3. Swisspearl Patina Inline Edge distances. Note! Min distance and/or the nearest following top line.

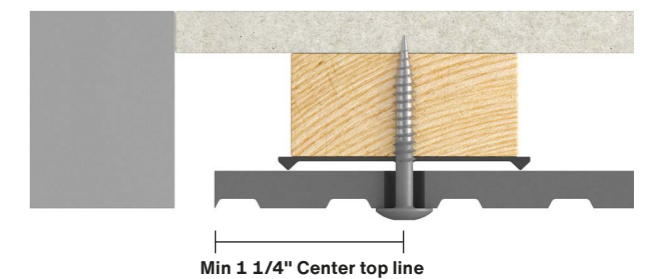

Fig. 4. Swisspearl Patina Inline installation of cut to size board.

Installation

Wind load

When installing Swisspearl facade boards, consideration should be given to the location of the building and which wind load the boards can be exposed to. In the table below, you find the screw distance as well as the support distances. Combining these two shows how much the board can withstand in kN/m².

It may be necessary to change support spacings/rievet distances at edge zones as the wind loads here may be higher than elsewhere on the building.

Swisspearl Patina design line - characteristic values

Maximum Screw distances "	Maximum batten distances "			
	11 13/16"	15 3/4"	23 5/8"	24 49/64"
11 13/16"	9.99 kN/m ²	7.49 kN/m ²	3.53 kN/m ²	3.21 kN/m ²
15 3/4"	7.49 kN/m ²	5.62 kN/m ²	3.53 kN/m ²	3.21 kN/m ²
19 11/16"	5.99 kN/m ²	4.50 kN/m ²	3.00 kN/m ²	2.86 kN/m ²
23 5/8"	4.99 kN/m ²	3.75 kN/m ²	2.50 kN/m ²	2.38 kN/m ²

The calculations are based on ETAG 034. No additional safety factors have been added. The test on which the calculations are based is made by an accredited laboratory with Swisspearl Facade screws 4.8x38 mm and the substructure used in the manual. The calculations are also based on the following material of the substructure; Wood C24 of minimum 3/4" thickness including a 5/16" board and 3mm EPDM.

If other types of screws are used, Swisspearl cannot vouch for the numbers in the chart. For high buildings or buildings located in exposed areas, there may be a need for specific wind load calculations and simulations, in which case you can contact Swisspearl for further information. There may also be situations where additional support and screws are needed in edge zones of the building. The wind load calculation should always be done according to local rules, regulations and the substructure has to be installed correctly as well, so it can withstand the wind load.

Installation

Fixing points for Swisspearl facade boards

To make the installation on wood easier, Swisspearl facade boards can be installed using two fixing positions and all other positions should be sliding points. These positions should be as close to the board centre as possible and must be aligned horizontally.

When installing Swisspearl facade boards using screws, you must start with the fixing positions, followed by the sliding points above the fixing positions and finally the sliding points below (see illustration below)

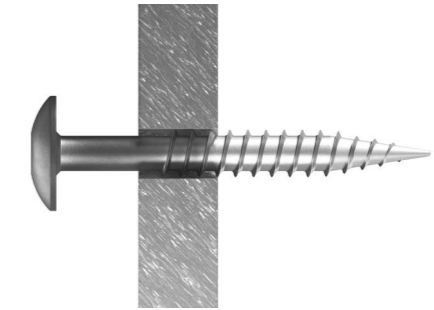

X : Fixing position hole diameter Ø5.5 mm.

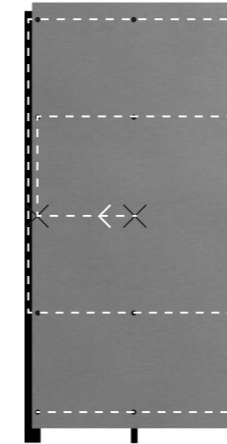
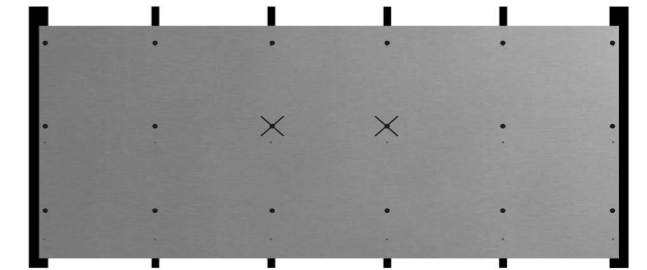
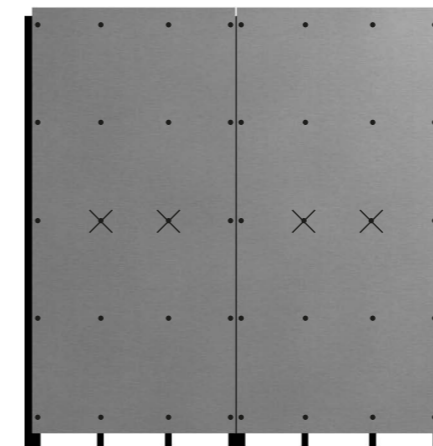

Illustration of correct screw installation. The fix points are marked with x.



Example: Horizontally mounted boards with four intermediate wood batten



Example: Vertically mounted boards with two intermediate wood batten

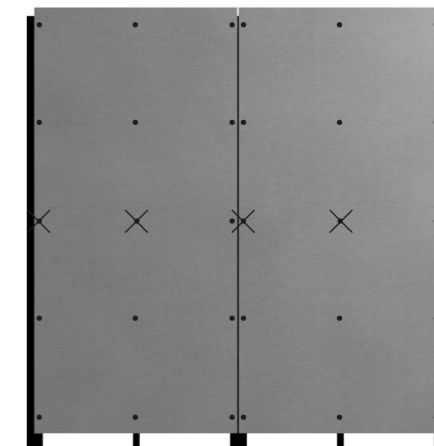

Example: Vertically mounted boards with one intermediate wood batten

Installation

Ceiling and soffit

Swisspearl facade boards is ideal for use in ceilings and soffits. The solution can be used for both exterior and interior applications. The boards can be installed on a batten directly to a concrete deck or wooden structure, or they can be used as part of a solution with a suspended ceiling system.

One of the key advantages of using Swisspearl facade boards is that you can easily take down boards so you can reach any hidden installations as the boards are mounted using screws only.

Installing 8mm Swisspearl facade boards on timber frame - as ceiling or soffit

Max support distances: 15 3/4" o.c
Max screw centres: 15 3/4"

The edge distances when using Swisspearl facade boards as ceiling or soffit are in principle the same as for facade boards in which the direction of the substructure and the orientation of the board define the edge distances. This also applies to hole sizes, joints and distances to other building materials.

Always use Swisspearl EPDM with ribs on timber battens.



Screw and batten distances

Fascia solution

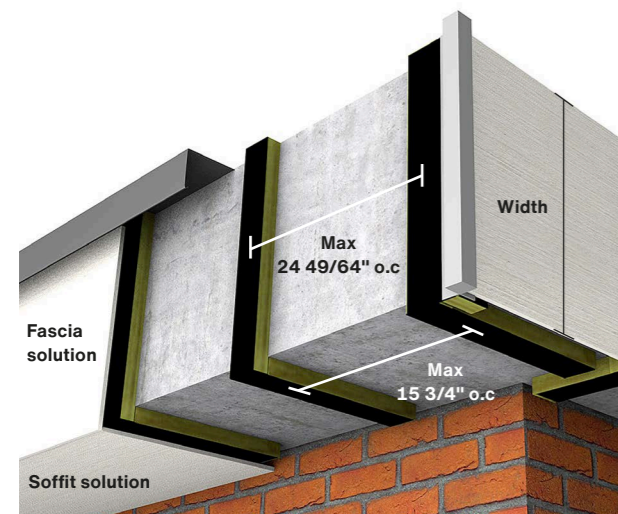

Installing 8mm Swisspearl facade boards on timber frame - as fascia boards

Max support distances: 24 49/64" o.c
Max screw centres: 23 5/8"

When mounting Swisspearl facade boards as fascia boards, boards below 11 13/16" width can be mounted directly using a 1/8" EPDM without ventilation battens behind the boards. When installing fascia boards of 11 13/16" width and more, it is necessary to keep a ventilation area behind the boards as with regular Swisspearl facade boards.

For both solutions, make sure to keep a 3/4" ventilation gap in both the top and the bottom of the fascia solution. Always use Swisspearl EPDM with ribs on timber battens.

Installation

Cut outs

To avoid cracking of the boards, when installing Swisspearl facade boards around windows, doors and other openings, ensure that the facade boards are installed correctly using Swisspearl's instructions.

Swisspearl recommends to avoid cutting single, exact apertures in boards, but instead you should cut smaller sections and install them individually.

Cut the boards and make vertical joints of 5/16". Make sure that there is support behind the joints, onto which the facade board can be mounted.

If the small cut outs are not wider than 4" - 5 29/32", they can be mounted with only one rivet/screw in the middle of the board (a). This also applies when using the Swisspearl facade boards in other solutions on a building as window jambs or in connection with other narrow spaces.

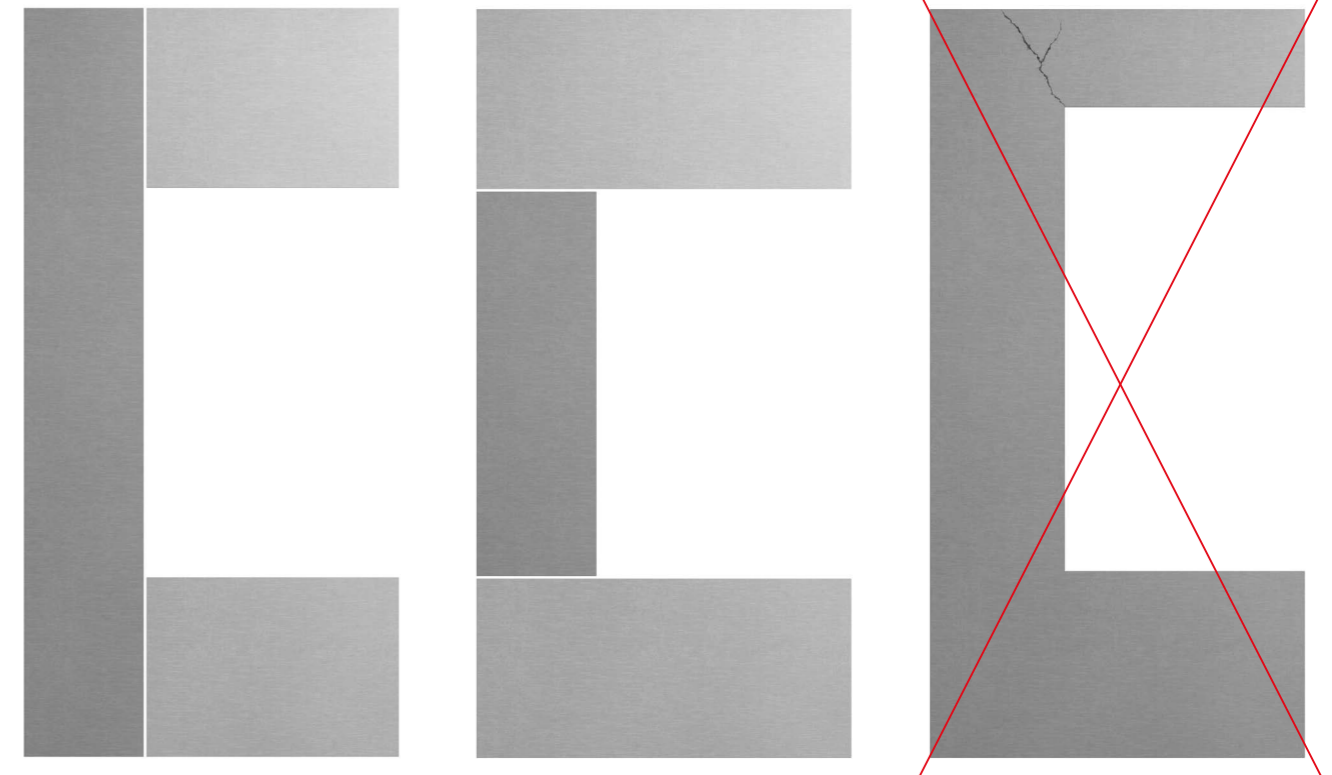
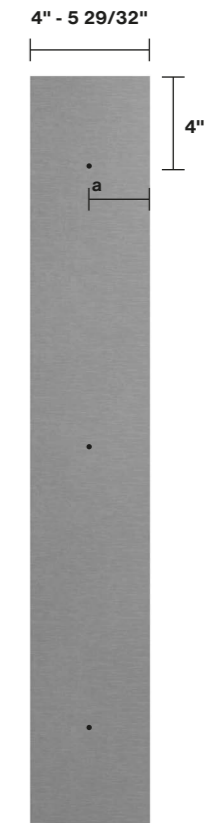

Correct installation of Swisspearl facade boards at windows, doors and openings.

Incorrect installation of Swisspearl facade boards at windows, doors and openings.

Installation

General distances

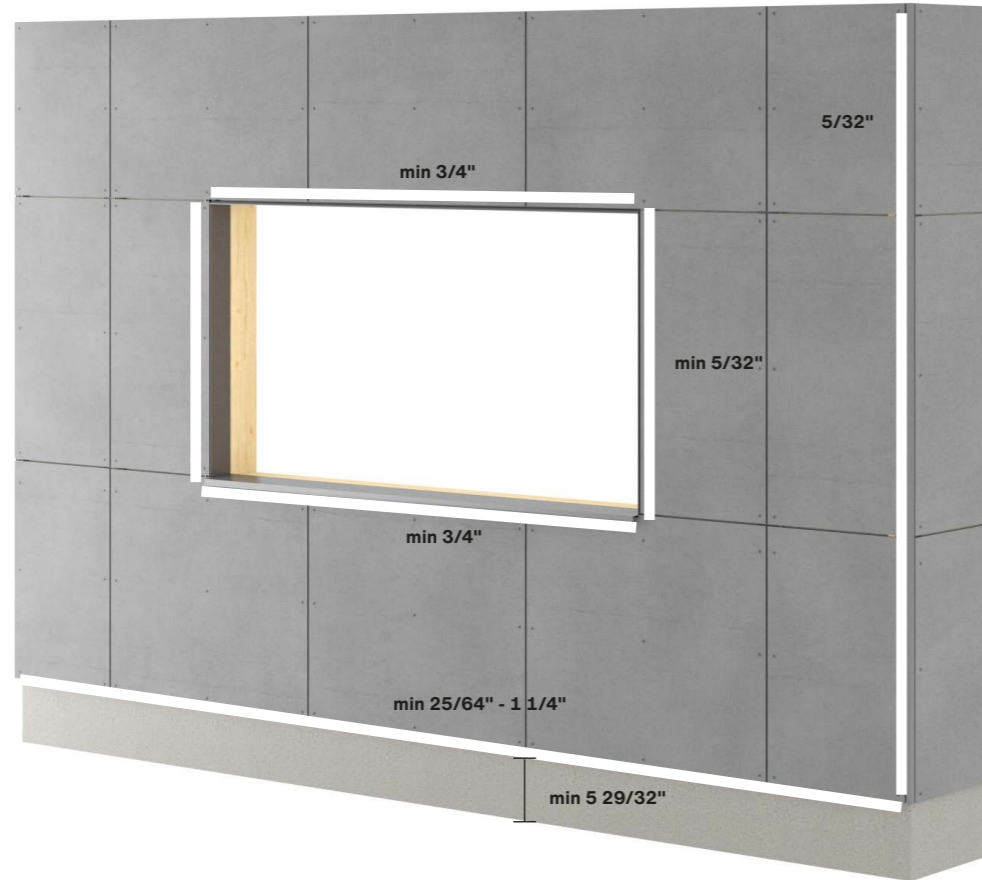

Make sure to follow the guidance regarding distances described in this manual.

The facade board should finish between $25/64'' - 1\ 1/4''$ below the bottom end of the sub structure. For overhang and similar, the maximum distance is 4\".

The distance to terrain from the bottom edge of the facade board should be a minimum of $5\ 29/32''$.

The distance to flat roofs, balconies and other horizontal structures where the water can drain away can be a minimum of 2\".

Vertical clearance to profiles such as Swisspearl alu trim or Swisspearl Corner profile is minimum $5/32''$. For horizontal clearances at windows and doors etc. leave a minimum of $3/4''$ for ventilation.

The clearance to other building materials is minimum $5/16''$ for movement and water drainage.

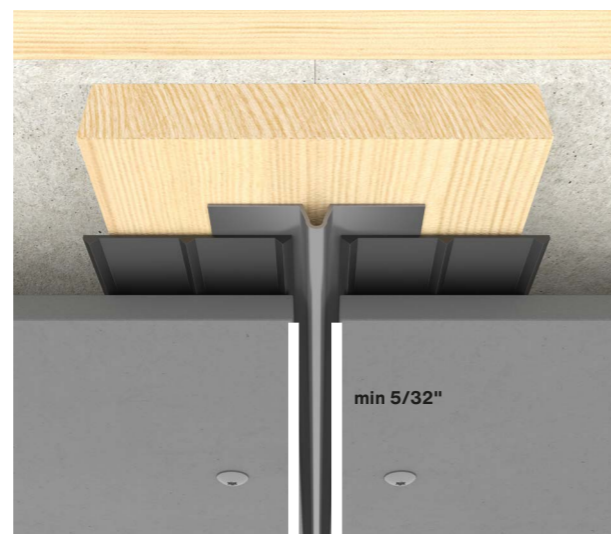

Installation

Details



External corner solution with open joint

Make an external corner solution without a Swisspearl corner profile. There should be a vertical joint between the facade boards in the corner of minimum $5/32''$. Swisspearl recommends using a 4\" EPDM and bend it around the corner to protect the wood.

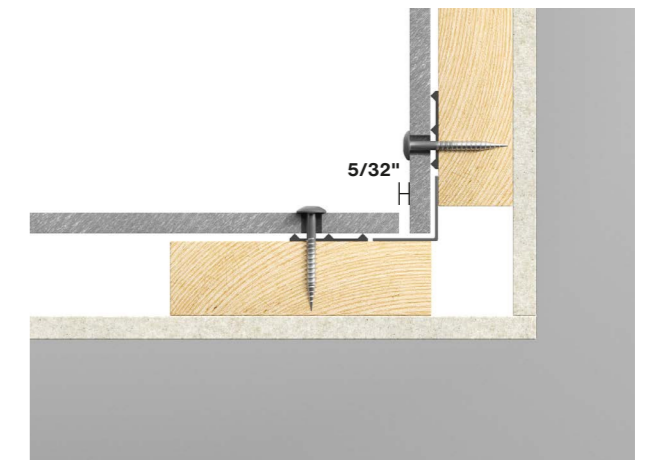

Internal corner solution with open joint

When making an internal corner, there should be a vertical joint between the facade boards of minimum $5/32''$. You can choose to either use 2x2\" EPDM or a 4\" EPDM and bend it around the corner to protect the wood.

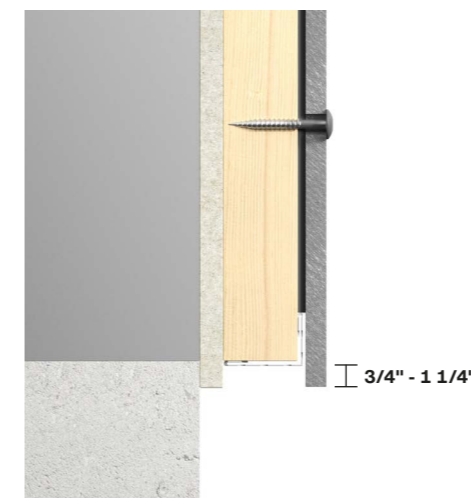

Plinth construction/ bottom construction

Ensure that the facade board exceeds the substructure by $3/4'' - 1\ 1/4''$, allowing the water from the facade to drip of. Use a ventilation grill to ensure that bugs/vermin do not enter the construction behind the facade board.

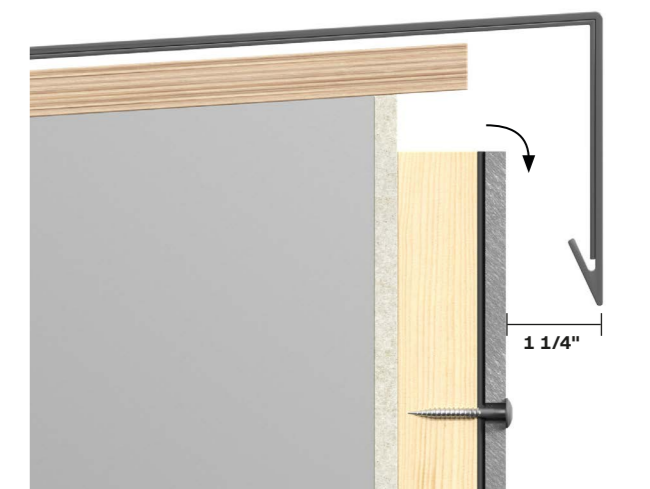

Top construction

Make sure that the ventilation can move freely to the top of the construction. As for the rest of the ventilation gaps, there should be a minimum free opening area of $3/4''$, or equivalent 200cm^2 per meter. There should be a minimum of $1\ 1/4''$ from the facade board front to the drip edge of the capping.

Installation

Details

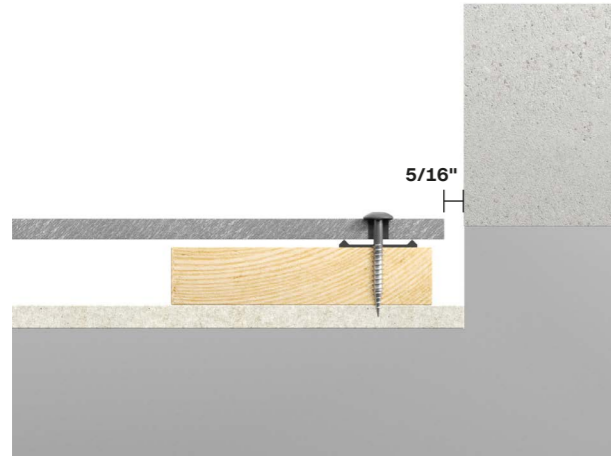

Endings / Finishing

Behind the facade board, a ventilated batten of min 2" width should be installed and there must be a minimum of 5/16" clearance to other building materials to allow for structural movements and proper water drainage and ventilation.

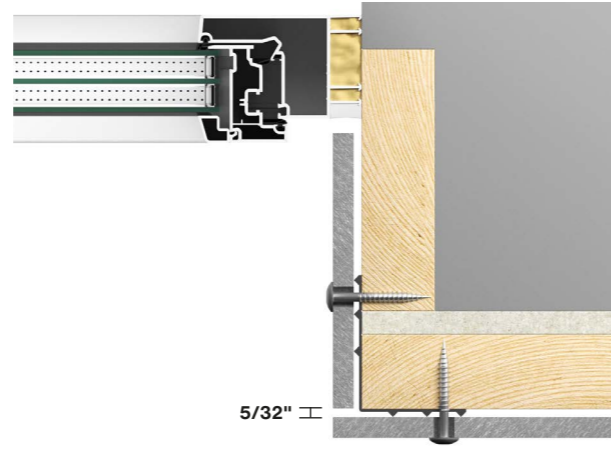

Window jamb

Swisspearl facade boards can be used for window jambs and returns.

Cut the facade boards to fit the depth of the window jambs. When mounting with one screw, the width of board should not exceed 7 7/8".

If the depth is more than 7 7/8", additional screws or a window U profile, into which the facade board can be inserted, must be used.

There should be a vertical joint of minimum 5/32" between the facade boards.

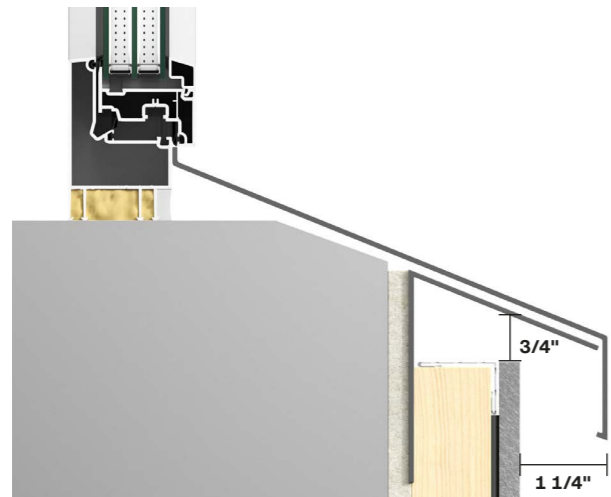

Window Sill

Swisspearl facade boards should not be used as sills. We recommend the use of formed aluminium or steel profiles. It is recommended that the sill projects a minimum of 1/14" beyond the face of the facade. There should be a minimum free open area of 3/4", or equivalent 200cm² per meter between the top facade board and the sill to ensure adequate ventilation behind the facade.

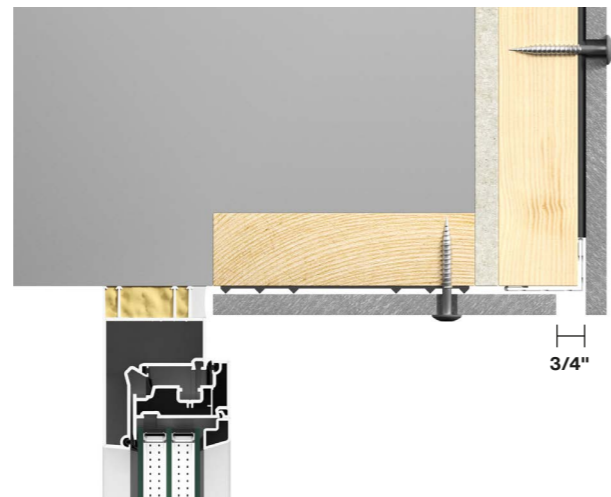

Window head

As with jambs, the window head can be formed using a Swisspearl board. At the front edge of the head detail, ensure a minimum free opening area of 3/4", or equivalent 200cm² per meter to ensure adequate ventilation behind the facade. Use a Swisspearl Ventilated Profile to ensure that insects/vermin cannot enter the construction behind the board. Please follow same details as for window jambs.



Accessories

All Swisspearl Facade Screws have mushroom heads with a torx 20 drive. Swisspearl Facade Screws are supplied as unpainted or in colours corresponding to the facade boards. It comes in two steel qualities, A2 and A4. A2 is the standard quality available in several lengths, whereas A4 steel quality is only available in one length.

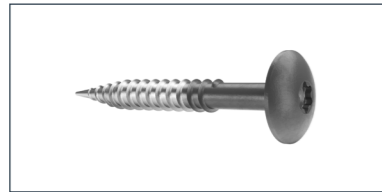

Swisspearl Facade Screw wood
SCR-W 4.5x30 /38 /44mm
A2 stainless steel
(Swisspearl Patina design line)

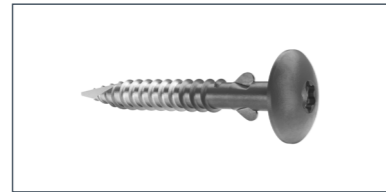

Swisspearl Facade Wing Screw wood
SCR-WW 4.9x38mm
A2 stainless steel
(Swisspearl Patina design line)

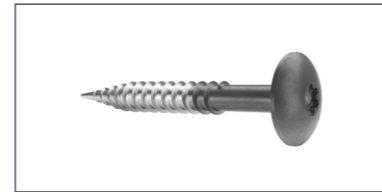

Swisspearl Facade Screw wood
Without washer
SCR-W 4.8x40mm
A4 stainless steel
(Swisspearl Patina design line)

Swisspearl EPDM 4"
For supporting battens



Swisspearl EPDM 3x100mm
30m/roll Black

Swisspearl EPDM 2"
For centre battens



Swisspearl EPDM 3x50mm
30m/roll Black

Swisspearl Blades

For cutting Swisspearl facade boards, the following blades can be used.

Diameter	Ø160	Ø190	Ø216	Ø250
Thickness mm	2.2/1.6	2.2/1.6	2.2/1.6	2.2/1.8
Centre hole mm	20	30	30	30
RPM	4800	4000	3500	3000
Teeth	6	4	6	14



Drill

For pre-drilling of Swisspearl facade boards, please refer to your local Swisspearl office for instructions.

Diameter 8mm



Accessories

Swisspearl Facade Screws

Swisspearl Facade Screw

For Swisspearl Patina design line boards, you should use the Swisspearl Facade Screw.

For timber batten substructure, Swisspearl offers the SCR-W screw in three different screw lengths; 30mm and 38mm for one layer of boards and 44mm for two layers of boards.

Pre-drilling

For pre-drilling, it is recommended that you use a drill bit Ø8mm that is suitable for fibre cement (Fig. 2). This leaves you with the best results and the optimum number of drilled holes per drill bit.

Dust from cutting or drilling must be removed with a brush or compressed air immediately after the work has been completed, otherwise it can mark the surface of the boards.

Applying Swisspearl Facade Screws

Ensure that Swisspearl Facade Screws are centrally located in pre-drilled holes. The screw must be angled 90 degrees to the facade board.

When inserting the Swisspearl Facade Screw, please be careful not to overtighten the screw - especially near the edges and corners of the boards.

Swisspearl Wing Screw

If using Swisspearl Wing Screw SCR-WW (4.9x38mm), no pre-drilling is necessary (Fig. 3). These screws are 'self-tapping' with cutting edges that create the correct hole diameter at the marked positions on the boards.

Screw quality

Swisspearl offers facade screws in A2 and A4 stainless steel. A2 is the standard choice for suburban or rural environments, while A4 is recommended for more demanding conditions, such as heavy industrial or coastal areas. Please note that the A4 screw is only available in one length for timber. To prevent surface contamination, screws should be cleaned regularly.

Maritime Conditions

Maritime conditions are typically defined as being within 1 km from the sea. The material specifications for the subframe, fasteners, and accessories should meet local standards for such environments. Ensure that the performance of the support system and accessories used complies with country-specific standards, approvals, and regulations.

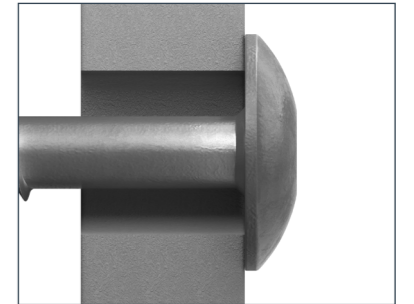

Fig. 1

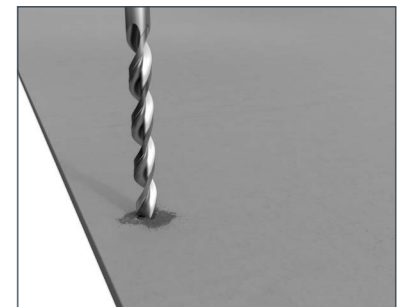

Fig. 2



Fig. 3

Accessories

Swisspearl Blade

To ensure a neat finish when cutting Swisspearl facade boards, it is important to use the correct blade. Swisspearl recommends using Swisspearl Blades as they have been customised for the purpose and leave you with the best end-result.

The blades have trapezoidal diamond teeth which provide excellent cutting quality and extremely long durability. In addition, the amount of dust generated is significantly reduced compared to similar blades.

The Swisspearl Blade is available in 4 sizes depending on which saw is used.

The Swisspearl blade can be used with dive saw, circular saw and stationary circular saw.

The Swisspearl Blade is a high quality product that can be sharpened, thus improving asset cost efficiency. To achieve the best quality cut and to know which side to cut from, make sure to follow the instructions shown here. The direction varies depending on which saw you use.

Handling

When cutting the facade boards, do not force the sawblade through the board. If you force the saw, the blade might overheat causing small vibrations -affecting the straightness of the cut or causing the board to flake if near the edges. The blade depth must be adjusted so that the blade goes max 10mm through the board.

It is important to remove dust caused by cutting and drilling immediately either with a soft brush or a vacuum cleaner as it otherwise might damage the boards. Ensure that the boards are properly cleaned before installation, and if necessary use clean water, or water with a mild detergent and a soft sponge, or brush to remove dirt and dust from the surface.

Local requirements regarding safety must always be followed. Make sure to use correct safety equipment such as masks and dust ventilation and ensure that the saw is set up correctly according to the manufacturer's instructions.

Never use water when cutting Swisspearl facade boards.

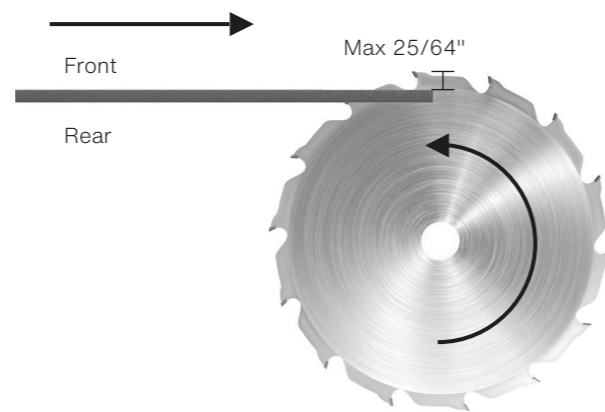

When using a table saw, place the board with the face up-most on the table and cut from the rear of the board.

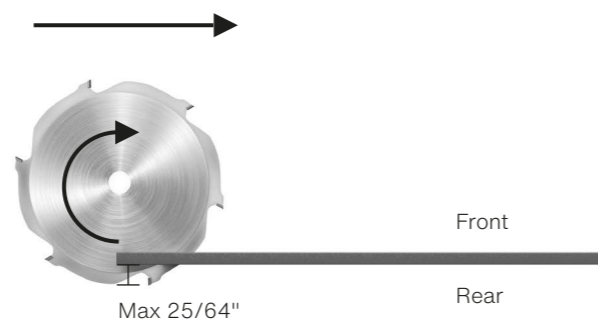

When using a mitre saw, cut the board from the front.

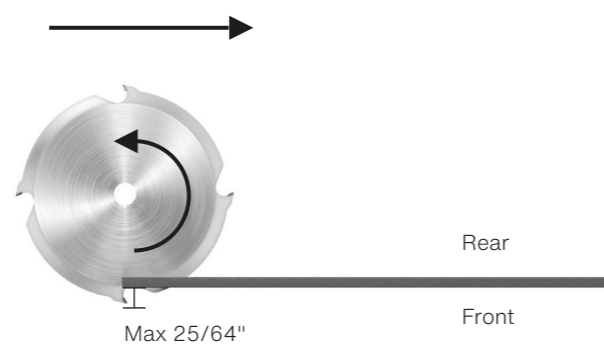

When using a circular saw or dive saw, cut the board from the rear.

Storing and Handling

Swisspearl products are delivered with plastic protection cover. If undamaged, the plastic cover provides good protection against dust and weather conditions during transportation.



Always store Swisspearl products on a flat dry level surface.



Only two pallets must be stacked on top of each other. Make sure they are positioned so they stand securely and stable.



If the pallets are stored outside when they arrive at the building site, the plastic cover should be removed. The facade boards should be stored on the pallet or sleepers with max 500mm distances.



Replace the plastic with a tarpaulin. It is very important that there is ventilation all around the tarpaulin and also on top of the pallet under the tarpaulin. This is done to make sure that condensation is reduced as much as possible.

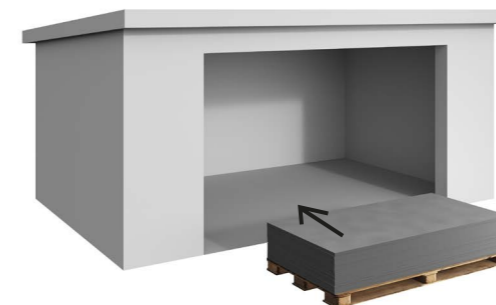

If Swisspearl facade boards are stored more than 2-3 weeks on site, the pallets should be kept under a roof to ensure dry and ventilated conditions.



Do not drag products from the pallet, as it may leave permanent scratch marks. Lift the product by its narrow edge as it may break if handled incorrectly.

Care & Maintenance

On-site

Cleaning of boards after cutting and drilling

It is important to immediately remove dust caused by cutting and drilling from the front and rear of the boards with a soft brush/duster or a vacuum cleaner, as it otherwise might damage the boards. Ensure that the boards are properly cleaned before installation, and if necessary use clean water or water with a mild detergent and a soft sponge or brush to remove dirt and dust from the surface. Thereafter, wipe the boards with a damp cloth. It may also be necessary to wash the surface after installation if the building site conditions have been unfavourable. This is done with lots of clean water or water with a mild detergent and a soft sponge or brush and finally wiping the boards with a damp cloth.

Removal of calcium-based residues

Calcium carbonate residue may occasionally be seen on the board surface. This can be difficult to remove with water or even with detergents because it does not dissolve in water. For cleaning purposes 10% acetic acid (CH₃COOH) solution is used to dissolve the calcium compounds.

Note! Carefully observe safety precautions (MSDS) when working with acetic acid. R-phrase R36/R38 is valid: "Irritating to eyes, respiratory system and skin". Use proper clothing, nitrile rubber gloves, eye protection goggles and approved respirator (filter A, E or A/E).

Carry out the mixing outdoors. Apply the diluted 10% acetic acid solution evenly with a spray can to the surface of the stained board. Leave it to react for a few minutes. Do not allow the solution to dry, but rinse with lots of clean water. Repeat the process if necessary and rinse with water afterwards.

Note! Do not execute the cleaning process with acetic acid in direct sunlight or on hot surfaces. This might create permanent stains.

Cleaning of neighbouring areas

Windows and glass in particular but also other adjacent areas must be kept clean during the facade board installation and if necessary protected with plastic film. Alkaline leaching from cement bonded materials (dust from cutting or drilling holes in structural concrete, etc.) is prone to damaging glass and other materials. Therefore, frequent cleaning during and after the construction period is needed.

Surface damages and scratches

Damages and scratches should be avoided by lifting the boards off the pallet and handling them carefully during installation. Scratches might leave white streaks on the surface which will turn dark when exposed to rain, because the board absorbs water through the scratch. Repair paint is not available. In any case the dark area will diminish after 6 to 12 months, because of the carbonation reactions in the cement matrix of the board.

Behaviour in wet conditions

Since the boards are made of Portland cement, their colour may turn darker when exposed to rain if the board absorbs moisture through holes, scratches or insufficiently sealed edges. This is natural behaviour for any cement-based product and it does not affect the integrity or long-term durability of the board. The original colour is restored as soon as the boards dry out. The darkening will show after heavy rainfall for the first months after installation. It will gradually reduce within 6 to 12 months, because the cement-based matrix reacts with carbon dioxide from the atmosphere – carbonation – and thereby reduces water penetration.

Care & Maintenance

After installation

Annual Inspection

Normally Swisspearl facade boards do not require any maintenance. Weathering may however influence the appearance of the facade. Therefore, an annual inspection of the ventilation gaps, joints and fixings is a good idea.

Detection and repair of possible damage ensures a prolonged lifespan for the facade.

Cleaning

Swisspearl facade can be cleaned with cold or lukewarm water if necessary with the addition of a mild household cleaning agent not containing solvents. Always start from below with well-defined areas. Rinse with plenty of clean water until the facade is perfectly clean. Before cleaning full scale, it is recommended to test the chosen cleaning method on a smaller area to ensure it works and does not damage the board surface.

High-Pressure Cleaning

Warning! High Pressure Cleaning is a severe treatment for fibre cement facade. Exaggerated or wrong use of a high pressure cleaner may damage the surface. Therefore, High Pressure Cleaning is not recommended.

Moss & algae

Moss and algae growth can be removed with common agents available on the market. Care should be taken to ensure that the cleaning agent does not cause damage to the surface of the Swisspearl facade boards.

Confirm the compatibility of your cleaning agent with your cleaning agent supplier, and ensure it is applied according to the supplier's instructions. It is advised that before conducting a large-scale application a test is carried out on a small, inconspicuous area to ensure that the cleaning agent has no effect on the colour of Swisspearl facade boards.

Efflorescence

Efflorescence is a naturally occurring, white, powdery deposit that can appear on cement-based building materials (including bricks, cement walls, grout, and fibre cement). It is the result of a process in which moisture draws salt crystals to the surface, evaporates, and leaves a chalky substance behind. Efflorescence occurs when all three of the following conditions exist:

1. Water-soluble salts are present in the building material.
2. There is enough moisture in the wall to turn the salts into a soluble solution.
3. There is a path for the soluble salts to get to the surface.

Efflorescence may also be a sign of water ingress behind the facade. Make certain that all openings are properly covered and there is no water intrusion due to over-driven nails. While some efflorescence may weather away naturally on its own, it is best to take steps to treat it.

Efflorescence can be removed with household white vinegar and water. For most cases of efflorescence, Step 1 - 3 works well. But for substantial deposits of efflorescence go to Step 4.

For best results, follow these cleaning instructions:

1. Protect areas that are not to be cleaned. Rinse all plants and vegetation around the facade with water before and after application of the vinegar.
2. Generously coat the entire surface area with vinegar. Allow the solution to sit on the surface for 10 minutes.
3. Rinse the treated area thoroughly with water from the top down and allow the area to air dry.
4. For extra tough efflorescence: Use a 10% acetic acid solution and apply to affected area with a cotton cloth. A light scrubbing with the cotton cloth may be required. After about 20 seconds rinse with water.

Health and Safety

As with all building materials, safety precautions must be taken into account and local laws and regulations must be observed.

Cutting and drilling

When cutting, grinding or drilling, dust from the fibre cement boards is released. This dust is characterised as mineral dust. Breathing large amounts of dust may cause irritation to respiratory functions, eyes or skin. Therefore, Swisspearl always recommends wearing personal protection equipment or stated by local law (Safety goggles, safety suit and a respiratory mask - P2 marked).

When cutting Swisspearl facade boards ensure adequate ventilation.

If the boards are cut indoors, it may be necessary to use an extractor system or a HEPA filter vacuum attachment attached to the power saw. When cutting outdoors, you should also use a HEPA filter vacuum attachment to the power saw. If ventilation is not adequate to limit exposure, wear a disposable respirator or air purifying cartridge respirator fitted with a Class P2 filter (European EN 143 standard). To reduce exposure to dust, Swisspearl recommends using Swisspearl Circular Blade.

Lifting Swisspearl facade boards

When lifting Swisspearl facade boards, please consider your lifting methods both in terms of safety but also to avoid damaging the boards.

When lifting or moving the facade board, please make sure to lift the board by its narrow edge as it may otherwise break if handled incorrectly.

If lifting Swisspearl facade board manually, make sure to adhere to any local rules. When lifting large boards, use mechanical lifting gear if possible. If this lifting gear uses suction/vacuum, be careful not to apply too much suction, as this may damage the surface or leave permanent marks.

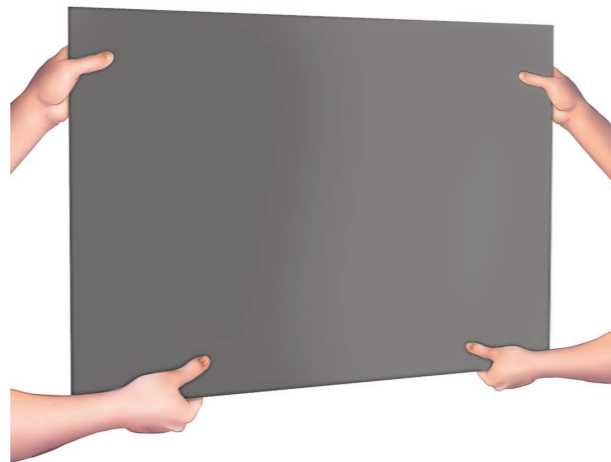
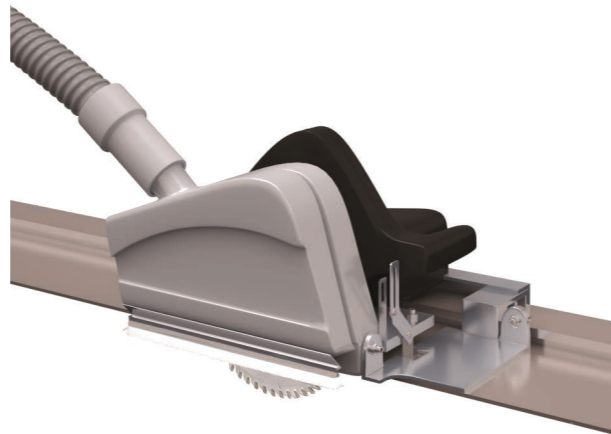

Onsite Handling

Swisspearl facade boards are supplied with a polyethylene foam layer between each board to prevent scratching and damage to the surface. The polyethylene is an environmentally friendly polymer that can be disposed of as normal combustible waste.

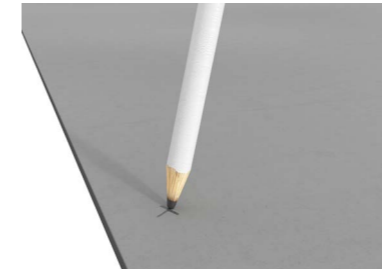

When marking the boards, make sure that marks are no larger than the hole to be drilled or no thicker than the blade that is to cut the board, as it can be difficult to remove marks from the board afterwards.



Once boards are cut, you can bevel the cut edge with a fine grinder (80 grain) to give the edge a pre-cut finish. The bevel should be angled at 45° relative to the board. This retains edge strength and removes small irregularities.

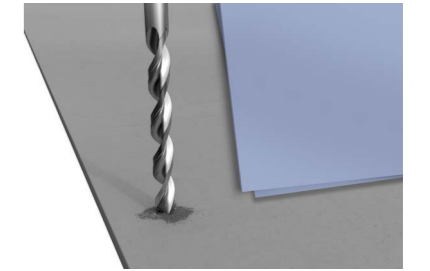

If not using Swisspearl Facade Wing Screws, the boards should be pre-drilled with an appropriate fibre cement drill bit. Dust from cutting or drilling must be removed with a brush or a fiber cloth immediately after the work has been completed, otherwise it can mark the surface of the boards.





Swisspearl Group AG

Eternitstrasse 3
8867 Niederurnen
Switzerland
T: +41 55 617 11 60
info@swisspearl.com

swisspearl.com